



JEFFERSONIANA

*Contributions from the
Virginia Museum of Natural History*

Number 3

October 30, 1993

THE AMERICAN SPECIES OF *ESCARYUS*,
A GENUS OF HOLARCTIC CENTIPEDS
(GEOPHILOMORPHA: SCHENDYLIDAE)

Luis A. Pereira and Richard L. Hoffman

ISSN 1061-1878

THE AMERICAN SPECIES OF *ESCARYUS*,
A GENUS OF HOLARCTIC CENTIPEDS
(GEOPHILOMORPHA: SCHENDYLIDAE)

Luis A. Pereira and Richard L. Hoffman

Museo de La Plata, 1900 La Plata, Argentina, and
Virginia Museum of Natural History, Martinsville, Virginia 24112

ABSTRACT

Eight North American species of *Escaryus* are regarded as valid. A historical summary is provided for the genus, as well as observations on the taxonomic significance of various characters heretofore utilized to distinguish genera of schendylids. Known Palearctic taxa are listed. *Escaryus ethopus* Chamberlin, *E. liber* Cook & Collins, *E. missouriensis* Chamberlin, *E. monticolens* Chamberlin, *E. paucipes* Chamberlin, and *E. urbicus* (Meinert) are redescribed and figured from type material and/or additional specimens. *Escaryus delus* Chamberlin is considered to be a junior synonym of *E. ethopus*. *Escaryus cryptorobius* and *E. orestes* are described as new species, both from Whitetop Mountain, Virginia. *Escaryus japonicus* is removed from the North American list, the Alaskan specimen upon which Chamberlin's 1952 record was based having been found to be an individual of *E. ethopus*.

Examination of type material of species thought possibly referable to *Escaryus* shows that the nominal genera *Lionyx* Chamberlin 1960 and *Zygona* Chamberlin 1960, originally proposed in the Schendylidae, must be referred instead to the Geophilidae.

INTRODUCTION

The circumboreal genus *Escaryus* is of special biogeographic and phylogenetic interest because it is one of the few (and by far the largest) groups of the family Schendylidae whose members are obligate psychrophiles. Most schendylids are confined to tropical or subtropical parts of the world, and it is not clear why the species of *Escaryus* have become

adapted to high latitudes and cool climates. In any case, one consequence of psychrophily has been that such species are poorly represented in most museum collections (few collectors of the soil and litter fauna are active contemporaneously with schendylids during the colder months of the year) and present knowledge of the genus is notably deficient.

So far 33 nominal species have been described in *Escaryus* (most of them known from only one locality) from a vast generic range that spans the Holarctic region from the Caucasus Mountains to the Appalachians. Four species occur southward as far as Virginia, and one exceptional form appears to be restricted to the Interior Lowlands of North America. Our recent discovery of undescribed species in the mountains of Virginia, and the opportunity of the first author to study type material of most of the known Nearctic species provided the incentive and means for this contribution toward a better knowledge of the American species of *Escaryus*. Since our personal experience with these animals in life gives every assurance that specialized collecting techniques will disclose a number of additional localized forms, the present treatment may be considered a baseline to be expanded by future studies of Nearctic chilopods.

In the following pages we provide a brief historical summary of *Escaryus*, a key to the North American taxa we believe to be valid, detailed descriptions and illustrations for all of them, the proposal of two new species from montane Virginia, and a survey of the distribution of the genus.

The research upon which this treatment is based was initiated during the tenure of a Smithsonian Post-doctoral Fellowship to the first author, who wishes to express his appreciation to the authorities of the Institution for the opportunity to conduct his studies there in 1988. Dr. Jonathan A. Coddington is due special thanks for ongoing help and counsel, and for making the facilities of his laboratory available. Dr. Victor Fet very kindly provided translations from literature in the Russian language. Both authors are indebted to Prof. William A. Shear for providing a review of the manuscript in its final stages.

Materials, Methods, and Acknowledgments

During the preparation of this synopsis, we have been able to examine material of *Escaryus* preserved in the Museum of Comparative Zoology, Harvard University (MCZ) through Dr. H. W. Levi; the Biosystematics



Map 1. The known distribution of *Escaryus* in North America, generalized, the Baffin archipelago and Greenland are omitted. Five species are known from northeastern United States, two from Alaska, and one from Utah. It is very likely that the generic range is continuous between Alaska and Utah, and possibly also entirely across Canada.

Research Institute, Ottawa (CNC) through B. Skidmore; and the U. S. National Museum of Natural History (USNM) through Dr. Jonathan A. Coddington. Holotypes of the two new species which we collected in Virginia have been deposited in the Virginia Museum of Natural History (VMNH), paratypes are shared with MCZ and USNM.

Descriptive terminology is largely that developed by R. E. Crabill in numerous papers during the 1960s, and based on classical derivations. A few more recent terms are utilized, one of them being **toxicodene** (proposed in our 1991 paper on *Marsikomerus* for the venom-producing gland associated with the prehensors) and the new **median** and **lateral labromeres** for the structures previously referred to in English as "midpiece" and "sidepieces" of the labrum.

Numerical distribution of structures on the right and left sides of a surface is indicated by the numbers joined by a "plus" sign, i.e., "6+6" setae. Observed range is indicated by the extreme values joined by a dash, i.e., "37-43" segments, *except* in the case of mandibular dentition, indicated by a three-number formula such as "3-4-4."

Specimens were temporarily mounted in creosote for microscopic study after immersion in acetic acid for a few hours. All of the illustrations were made by the first author, using a compound microscope equipped with a camera lucida drawing tube.

SYSTEMATICS

Family **Schendylidae** Cook

- Schendylidae Cook, 1896, Proc. U. S. Nat. Mus., vol. 18, p. 70.—
Chamberlin, 1947, Ent. News, vol. 58, p. 146.
Schendylinae: Brolemann & Ribaut, 1912, Nouv. Arch. Mus. Hist. Nat.
Paris, ser. 5, vol. 4, p. 53.—Attems, 1929, Das Tierreich, lief. 52, p.
58.—Crabill, 1961, Ent. News, vol. 72, p. 29.

The content and extent of this family heretofore has been expressed in two ways. In the usage of Cook and Chamberlin, it is held to be different from a supposedly allied taxon Ballophilidae. Attems, and following him, Crabill, combined the two as equivalent subfamilies of a more inclusive Schendylidae. For the present, we adopt the precedent of Cook, with the qualification that both taxa may be rediagnosed on the basis of characters

other than those traditionally employed. Just over 62 generic and subgeneric names have been proposed in the family as here defined, how many of these represent actual generic groups cannot be stated with present knowledge. Probably generic names published in other families will be found to be based on schendylids, just as we have found the reverse to be true (cf. p. 6).

Historical summary of Nearctic taxa

Apparently the first American schendylid to be described was named *Geophilus gracilis* by Oscar Harger in 1872, from material collected in Connecticut. As this name was preoccupied, it was replaced a few years later by Meinert (1886) who proposed the substitute name *Geophilus urbicus* for a species that he believed to be the same as *gracilis*. At that time, most geophiloid centipeds were referred to the genus *Geophilus* and family Geophilidae, even though the generic name *Schendyla* had been proposed in 1866 by Bergsøe & Meinert for a common European species. Classification of geophiloids was based largely upon rather superficial peripheral characters until Meinert's discovery of constant differences in mandibular structure. This breakthrough was successfully exploited by O. F. Cook, who in a significant early paper coauthored with G. N. Collins (1891) proposed the new schendylid genus *Escaryus* for two new species which were described and illustrated in detail and accuracy quite novel in chilopod taxonomy at that time.

Four years later, Cook (1895) published an outline of a new classification of geophilomorphs which he dispersed through nine families, seven of them, including the Schendylidae, proposed as new. As Cook had already published one of the other two families, and redefined the Geophilidae in a new and restricted sense, his innovative paper of 1895 established him as the "father of geophilomorph taxonomy" and most of his family groups remain in use today much as he first diagnosed them. At the time of its proposal, the Schendylidae contained five nominal genera: *Schendyla*, *Pectiniunguis*, *Escaryus*, *Nannophilus*, and *Ctenophilus*, all but the first two sired by Cook. As thus constituted, the family was represented by species in West and North Africa, Europe, eastern North America, and Baja California.

The first key to schendylid genera was published also by Cook in 1904, and included the new genus *Holitys* from New Mexico. An elegant revision of the family, replete with magnificent illustrations but deficient

in its treatment of the Nearctic fauna, was authored by Brolemann & Ribaut in 1912. In 1929 the Schendylidae was treated in Count Attems' synopsis of the order Geophilomorpha, a useful work but one of necessity based to a large extent upon literature compilation and therefore of somewhat equivocal reliability (error was also introduced by Attems' willingness to employ pragmatic shortcuts: *E. sibiricus* Cook, 1899, was cited as type species of the genus because he happened to have material of that species, but none of *E. phyllophilus* Cook & Collins, which had been designated as type species by Cook in 1895). This volume provided keys and descriptions for the schendylid genera and species known up to that time.

The first major update treating Nearctic Schendylidae was a key to the Mesamerican genera (Chamberlin, 1943), which included the eight taxa he had described over the preceding three decades as well as one each published by Bollman and Verhoeff. A much improved key, embracing all American schendylid genera known to that time, was later published by Chamberlin (1947) in a paper that proposed the nominal new genus and species *Cymochilus panamicola*. In a summary of the Chilopoda of Alaska, Chamberlin (1946) listed three species of *Escaryus*: *E. albus* Cook, and the two new species *E. delus* and *E. paucipes*. He provided also a short key separating these three taxa from each other and from the two Asiatic species *E. sibiricus* Cook and *E. japonicus* Attems. A few years later (1952) Chamberlin recorded the presence of the latter species also in Alaska, a point which we address in the following account of *E. ethopus* (p. 56).

In 1960, Chamberlin published two short papers in which supposed new American schendylid taxa were proposed. The first (1960a) embodied the description of a new genus and species, *Lionyx hedgpethi*, as well as a key to a number of genera selected without any apparent relevance except that many of them had littoral species or were in some way related to *Lionyx*. At least the key distinguished four genera whose species have numerous coxopleural pores: *Escaryus*, *Lionyx*, *Sogolabis*, and *Apunguis*. Unfortunately, of these four, *Lionyx* must be excluded from the Schendylidae, as a recent examination of the type species *L. hedgpethi* (USNM) shows it to belong in the family Geophilidae. The second paper (1960b) defined the new genera and type species *Gosendyla socarnia* (Utah) and *Zygona duplex* (Arizona). The first of these appears to be very closely related to, if not congeneric with, *Escaryus* and will be discussed under the generic heading, but *Zygona* (as established by study

of the type species) is not referable to the Schendylidae and must be relocated into another family, probably the Geophilidae. The two most useful papers of recent date are those published by R. E. Crabill in 1953 and 1961. The first of them is a synopsis of the Schendylidae of northeastern North America which provided keys, descriptions, distributional data, and literature references for the two genera and four species of the family known from that region. As such, and despite the absence of illustrations, it provided a good introduction to the status of *Escaryus* in the eastern part of its Nearctic range. The 1961 paper (which was in press when Chamberlin's 1960 work appeared) provided a catalogue of the schendylids known up to that time from Mexico and North America, and a key to the genera, which to some extent overlaps with that devised by Chamberlin (1943) for the taxa of Mexico and Central America. Moreover, Crabill's key was of necessity compiled in part by reference to Chamberlinian descriptions which contain errors both of commission and omission. Nonetheless this catalogue and key represented "state of the art" at the time of their preparation, and are the best existing references on American schendylids.

An important treatment of all known Eurasian forms of *Escaryus* was published in 1972 by L. P. Titova, who accounted for no fewer than 23 species and a number of subspecies and varieties. Although the descriptions were accompanied by illustrations of mouthparts and other characters, these lack the detail now considered to be essential for definition of species in this genus and it has been difficult to associate Titova's escaryids with possibly related Nearctic taxa. Moreover the publication of the paper in Russian renders it essentially inaccessible to investigators not versed in that language.

Species incorrectly referred to *Escaryus*

Escaryus albus Cook, 1904, was based on two specimens from the Pribilof islands, Alaska. More than a half century later, these types were examined by R. E. Crabill who reported (1961) that they are in fact immatures of "some species of *Strigamia*." According to the original description, the two were found among specimens of *S. chionophila* (Wood), and it is surprising that Cook would have misidentified them to family particularly as he obviously had some reason for sorting them out of numerous strigamias. We suggest that this case be held open to further investigation, not that Crabill's identification is suspect, but that some

clerical or curatorial error may have occurred (a by-no-means unusual event in myriapod collections): are the ostensible types of *albus* really the original specimens seen by Cook?

Genus *Escaryus* Cook & Collins

Escaryus Cook & Collins, 1891, Proc. U. S. Nat. Mus.— Cook, 1895, Proc. U. S. Nat. Mus., 18: 71.— Attems, 1903, Zool. Jahrb. Abt. Syst., 18: 196.— Attems, 1904, Zool. Jahrb. Abt. Syst. 20: 124.— Cook, 1904, Harriman Alaska Exped., 8: 76.— Attems, 1928, Ann. South African Mus., 26: 138.— Attems, 1929, Das Tierreich, 52: 94.— Chamberlin, 1946, Ann. Ent. Soc. America, 39: 178.— Chamberlin, 1947, Pan-Pacific Entom., 23: 37.— Chamberlin, 1947, Ent. News, 58: 147.— Crabill, 1953, Journ. New York Ent. Soc., 61: 95.— Crabill, 1961, Ent. News, 72: 35, 68.— Shinohara, 1970, Zool. Mag. (Dobut. Zass.) Tokyo, 79: 53.— Titova, 1972, Ecol. Invert. Terrest. (Moscow), 94: 116.

Name: *Escaryus* is of secondary classical origin, an anagram of the place name Syracuse (New York).

Type species: *Escaryus phyllophilus* Cook & Collins, 1891 [= *Geophilus urbicus* Meinert, 1886], by subsequent designation of Cook, 1895: 71.

Diagnosis: Labrum, especially median labromere, with well-developed dentations. Innermost block of dentate lamellae of mandibles subtended on mesal side by a group of "accessory teeth" having the form of sclerotized denticles or hyaline fimbriae. Coxosternal palps of 1st maxillae rudimentary (practically absent from some species), telopodital palps present, variable in size; claws of 2nd maxillae bipectinate. Sternal pores absent. Coxopleura of ultimate segment with numerous pores, each corresponding to a separate coxal organ; last pair of legs with seven podomeres, which are incrassate and invested with numerous tiny setae in the male sex, slender and less pilose in the female, pretarsus (claw) present, unguiform. Anal pores present. Gonopods biarticulate in both sexes.

Species: 33 taxa are here recognized, eight endemic to North America and 25 to the Palearctic Region (the nominal subspecies of *E. retusidens* named by Folkmanova, 1956, are considered to merit full specific status as they appear to be sympatric): *Escaryus altavicus* Titova, 1972

(Kazakhstan); *E. chadaevae* Titova, 1972 (Russia: Kemerovo Region); *E. chichibuensis* Shinohara, 1955 (Japan: Chichibu); *E. cryptorobius* n. sp. (USA: Virginia); *E. dentatus* Titova, 1972 (Russia: Primorski Krai); *E. ethopus* (Chamberlin, 1920) (USA: Alaska); *E. hirsutus* Titova, 1972 (Japan, Sakhalin Id.); *E. igarashii* Shinohara, 1955 (Japan: Chichibu); *E. jacoti* Verhoeff, 1934 (Korea); *E. japonicus* Attems, 1927 (Japan, eastern and central Russia); *E. kirgizicus* Titova, 1972 (Kirgizstan: Tien-Shan Mountains); *E. koreanus* Takakuwa, 1937 (Korea, eastern USSR); *E. krivolutskiji* Titova, 1972 (Russia: Primorsky Krai); *E. kusnetzowi* Lignau, 1929 (Kazakhstan); *E. latzeli* (Sseliwanoff, 1881); (Kirgizstan: Tien-Shan Mountains); *E. liber* Cook & Collins, 1891 (northeastern USA); *E. makizimae* Takakuwa, 1935 (Japan: Iida); *E. missouriensis* Chamberlin, 1942 (central USA); *E. molodovae* Titova, 1972 (Japan: Sakhalin Island); *E. monticolens* Chamberlin, 1947 (USA: Utah); *E. oligopus* Attems, 1904 (**stat. nov.!**) (Kirgizstan); *E. orestes* n. sp. (USA: Virginia); *E. ornatus* Folkmanova, 1956 (**stat. nov.!**) (Russia, Ukraine); *E. pallidus* Folkmanova, 1956 (**stat. nov.!**) (Russia, Ukraine); *E. paucipes* Chamberlin, 1946 (USA: Alaska); *E. perelae* Titova, 1972 (Russia: Primorsky Krai); *E. polygonatus* Titova, 1972 (Russia: Primorsky Krai); *E. retusidens* Attems, 1904 (Kazakhstan); *E. sachalinus* Takakuwa, 1935 (Japan: Sakhalin Island); *E. sibiricus* Cook, 1899 (Russia: Vladivostok); *E. urbicus* (Meinert, 1886) (northeastern USA); *E. vitimicus* Titova, 1972 (Russia: Buryatia); *E. yakumoensis* Takakuwa, 1935 (Japan: Hokkaido).

Distribution: Northeastern North America, from Virginia and Kansas north to New York, Massachusetts, and Minnesota; Utah; Yukon Territory, Canada; coastal and central Alaska; northern Japan; Korea; Russian Far East; Siberia; Confederation of Independent States west as far as Crimea, Moldavia, and the Caucasus Mountains. It is entirely possible that the distribution of the genus is continuous throughout this entire area (Map 1).

Generic criteria in the Schendylidae: It is well-known that genera are arbitrarily defined, and their composition is usually the result of a consensus. While we do not intend to discuss the philosophical implications of this subject on a broad canvas, a few observations about the definition of schendylid genera in the recent past will be germane to the treatment of *Escaryus*.

Knowledge of the North American fauna of Chilopoda stems to a very large extent from the work of R. V. Chamberlin, who particularly in his

later years adopted an extremely exclusive view of generic limits. As evident from his published papers, a single structural difference from some known and presumably related taxon was sufficient basis for establishment of a new genus (usually contrasted only with one occurring at some great distance from that being proposed). In a large number of cases, the "diagnostic" character for a new genus was one of reduction - thus *Gosendyla* was based on a species said to be similar to those of *Escaryus* in all respects except for the absence of a claw on the last pair of legs and *Morunguis* was said to differ from *Simoporus* only by the absence of sternal pore fields. The list could be greatly extended.

Admittedly geophilomorph centipeds are not replete with external character systems, and one is obliged to look carefully for ways to group species, but the danger of developing purely mechanical classifications is quite real if appeal is made to "present or absent" polarities. In the Schendylidae, as with other centipeds, the problem is to discover combinations of characters (or at least single characters) which have some fundamental significance, and are not subject to random adaptive suppression. *Escaryus* seems to be set off by two substantial conditions conjointly: the presence of numerous small pores on the coxopleurae of the last pair of legs, and bipectination of the second maxillary claw. So far the polarities of such characters among the Geophilomorpha have not been established, rendering cladistic analysis premature at this time, but the question may be reasonably posed: does a single difference (such as the loss of tarsal claws from the last pair of legs) from among an entire suite of characters, justify generic status for a single species? Recognition of such genera as *Gosendyla* hinges upon the investigator's subjective response to this point. The same rationale would apply equally well to the nominal Japanese genus *Falcaryus* (Shinohara, 1970), which was likewise based on a relatively trivial difference, possibly even an artifact.

The presence or absence of sternal pores has been frequently employed to distinguish nominal genera, without a distinction being made among cases in which all sterna are porose, only half of them, or perhaps only a few, as opposed to none. Perhaps distinctions arbitrarily made along the lengths of structural spectra should be regarded as undesirable for generic definition, if the variability *within* the "positive" expression of a trait is greater than between its minimal expression and its absence. We anticipate that more sophisticated future approaches to chilopod taxonomy - including both more detailed descriptions and the study of variability in populations - will vastly reduce the number of Chamberlin-

ian generic names. For the present, we defer to traditional approach and define *Escaryus* in a sense that admits *Gosendyla* as a separate genus. It should be obvious, however, that the groups within *Escaryus* defined by the first key couplet actually reflect far more phylogenetic significance than does the mere loss of tarsal claws. Dr. Chamberlin would have undoubtedly split *Escaryus* into two genera along those lines, had he but been aware of them.

Species Groups: Attems (1929) proposed to divide the species into two groups on the size of the ultimate leg claw (as large as, or smaller than, those preceeding). Takakuwa (1935) however found a spectrum of relative sizes among Japanese species, and remarked that "Es scheint mir sehr schwierig, diese Gattung, wie Prof. Attems versucht, in zwei Gruppen einzuteilen." We tend to concur in this observation, as the grouping proposed carried the liability of any based on a single criterion subject to variation.

On the other hand, we believe that the combination of characters shared by *Escaryus ethopus* and *E. missouriensis* (specified in the first couplet of the key to species below) so strongly suggests a close and exclusive relationship between these two taxa that we propose a basic dichotomy of the Nearctic species into two groups. Unfortunately, it cannot be asserted that the species placed in the "Urbicus Group" comprise a correspondingly monophyletic unit, as synapomorphic characters have not been identified with confidence for many of them. Obviously an adequate organization of the genus must await the revision of Asiatic taxa, the published descriptions of which do not provide necessary anatomical information.

The lack or inadequacy of material has compelled use of segment counts in several key couplets. This reliance upon a superficial character results in various associations of species which must not be construed as indicative of relationships. Eventually a new key can be developed that does not rely upon single-character couplet dichotomies.

Key to the Nearctic species of *Escaryus*

1. Paraclypeal suture incomplete (Figs. 126 and 107); lateral labromeres with reticulated surface texture (Figs. 141 and 110); anterior sterna without sacculi on front border; body large and robust, up to 65-73 mm long and 2 mm wide (Ethopus Group) 2

- Paraclypeal suture complete (Fig. 44); lateral labromeres without reticulated surface (Fig. 55); anterior sterna with transversely oval sacculi (except in *E. paucipes*); body length no greater than 40 mm, width less than 1.5 mm. (Urbicus Group) 3
2. 55–59 pairs of legs; coxopleura with approximately 44–100 small pores of uniform size; clypeus without plagulae; mandibles with 15–20 accessory teeth; pretergum of ultimate pedal segment with pleurite present; femur and tibia of prehensors without tooth; claw of 2nd maxillae with about 19 pectines, coxosternum with about 28+24 setae *E. missouriensis* Chamberlin
- 41–47 pairs of legs; coxopleura with from 35–65 pores of variable size; clypeus with two paramedian plagulae; mandibles with about 11 accessory teeth; pretergital pleurite of ultimate pedal segment absent; femur and tibia of prehensors dentate; claw of 2nd maxillae with about 11 teeth and coxosternum with about 16+15 setae
 *E. ethopus* Chamberlin
3. 31 to 35 pairs of legs 4
- 41 to 49 pairs of legs 5
4. Coxopleura with 23–27 pores; tarsal claws with squamose surface; body 19 mm long and 1 mm wide with 31–35 pairs of legs; palps of telopodites of 1st maxillae as shown in Figure 61; coxosternal palps of 1st maxillae rudimentary, sternum of last pedal segment as wide as long and invested with numerous short setae; lateral labromeres with 2+1 dentiform lobes (“teeth”), femur of last pair of legs 20% longer than its diameter; pretergital pleurite of the last pedal segment present; femur of prehensorial telopodite dentate on inner surface; 2nd article of 1st maxillary telopodite with 4+4 setae; ultimate antennomere with numerous claviform setae on its internal surface; 13th antennomere without large specialized ochraceous sensory setae; claw of 2nd maxillary telopodite with 6–8 pectines; accessory teeth of mandible hyaline *E. cryptorobius*, n. sp.

- Coxopleura with 8–10 pores; surface of tarsal claws smooth; body 14 mm long and 0.50 mm wide with 33 pairs of legs; palps of telopodites of 1st maxillae developed as shown in figure 136; palps of coxosternum of 1st maxilla well defined; sternum of last pedal segment 15% wider than long and without small setae; lateral labromeres with 6+6 teeth; femur of ultimate legs 80% longer than its diameter; pretergum of ultimate pedal segment without pleurites; femur of prehensorial telopodite without tooth; 2nd article of telopodite of 1st maxilla with 1+1 setae; ultimate antennomere with a few claviform setae on its internal surface; 13th antennomere with large ochraceous sensory setae; claw of telopodite of 2nd maxilla with four pectines; accessory teeth of mandibles sclerotized and opaque *E. paucipes* Chamberlin

- 5. Body with 47–49 pairs of legs *E. liber* Cook & Collins

- Body with 39–45 pairs of legs 6

- 6. Coxopleura with as many as 35 pores, each coxopleuron with two apical pores much larger than the others; body length to 32 mm, and width to 1.3 mm; males with 41 pairs of legs, females with 39–43 pairs *E. urbicus* (Meinert)

- Coxopleura with a maximum of 20 pores, none of which are evidently larger than the others; length of body 18 mm width 0.9 mm; 43–45 pairs of legs 7

- 7. Tarsal claws with squamose surface; 43 pairs of legs (female); pectinate lamella of mandibles with 18 teeth; median prolongation of 1st maxillary coxosternum with 4+3 setae; telopodite of 1st maxillae with 4+4 setae *E. monticolens* Chamberlin

- Tarsal claws with smooth surface; female with 45 pairs of legs, males with 43 or 45 pairs; pectinate lamella of mandibles with 11–12 teeth; median prolongation of coxosternum of 1st maxilla with 2+1 to 2+2 setae; telopodite of 1st maxilla with 3+1 to 2+2 setae
. *E. orestes* n. sp.

Urbicus-Group

Escaryus urbicus (Meinert)
(Figures 1-10, Maps 2, 3)

Geophilus urbicus Meinert, 1886, Proc. Amer. Phil. Soc. 23: 218. Holotype female (MCZ 966/TC 4) from Cambridge, Massachusetts, Winter 1872-73, Schwarz leg.—Cook & Collins, 1891, Proc. U.S. Nat. Mus. 13: 393.—Cook, 1896, Amer. Nat. : 240.—Attems, 1903, Zool. Jahrb. Abt. Syst. 18: 197.—Attems, 1929, Das Tierreich, 52: 327.

Escaryus phyllophilus Cook & Collins, 1891, Proc. U. S. Nat. Mus., 13: 392. Holotype (present location, if extant, unknown) from Kirkville, New York.—Cook, 1895, Proc. U. S. Nat. Mus. 18:71.—Cook, 1896, Amer. Nat.: 240.—Cook, 1899, Proc. Ent. Soc. Wash., 4: 304.—Attems, 1903, Zool. Jahrb. Abt. Syst., 18: 196.—Attems, 1904, Zool. Jahrb. Syst. 20: 124.—Chamberlin, 1909, Ann. Ent. Soc. America, 2: 177.—Attems, 1927, Zool. Anz., 72: 303.—Attems, 1929, Das Tierreich, 52: 95, 97.

Escaryus urbicus Cook, 1896, Amer. Nat., 240.—Cook, 1904, Harri-man Alaska Exped. 8: 76.—Chamberlin, 1912, Canadian Entom., 44: 66.—Williams & Hefner, 1928, Bull. Ohio State Univ., 33(7): 135.—Bailey, 1928, Bull. New York State Mus., 276: 19, 43, 44.—Chamberlin, 1947, Pan-Pac. Entom., 23: 37.—Crabill, 1953, Journ. New York Ent. Soc., 61: 96.—Crabill, 1958, Ent. News, 69: 93, 94.—Crabill, 1961, Ent. News, 72: 71.—Kevan, 1983, Canad. Journ. Zool., 61: 2945.

Material: Female holotype, with 41 pairs of legs, preserved in alcohol, presently in rather poor state of preservation, labeled "*Geophilus urbicus* Meinert HOLOTYPE. Cambridge, Winter 1872-73 Schwarz." Also eight specimens from VIRGINIA: Giles County: Mountain Lake, 3800 ft., 1 January 1952, R. L. Hoffman leg., 1 female 27 mm long with 41 pairs of legs and 1 male 26 mm long with 41 pairs of legs (both identified as *urbicus* by R. E. Crabill and in his personal collection, presently housed

→

Figures 1-4. *Escaryus urbicus* (female from Mountain Lake, Va.). 1. Ultimate pedal and postpedal segments, ventral view. 2. The same, dorsal aspect. 3. Prehensorial segment, ventral view. 4. 1st and 2nd maxillae, ventral view.

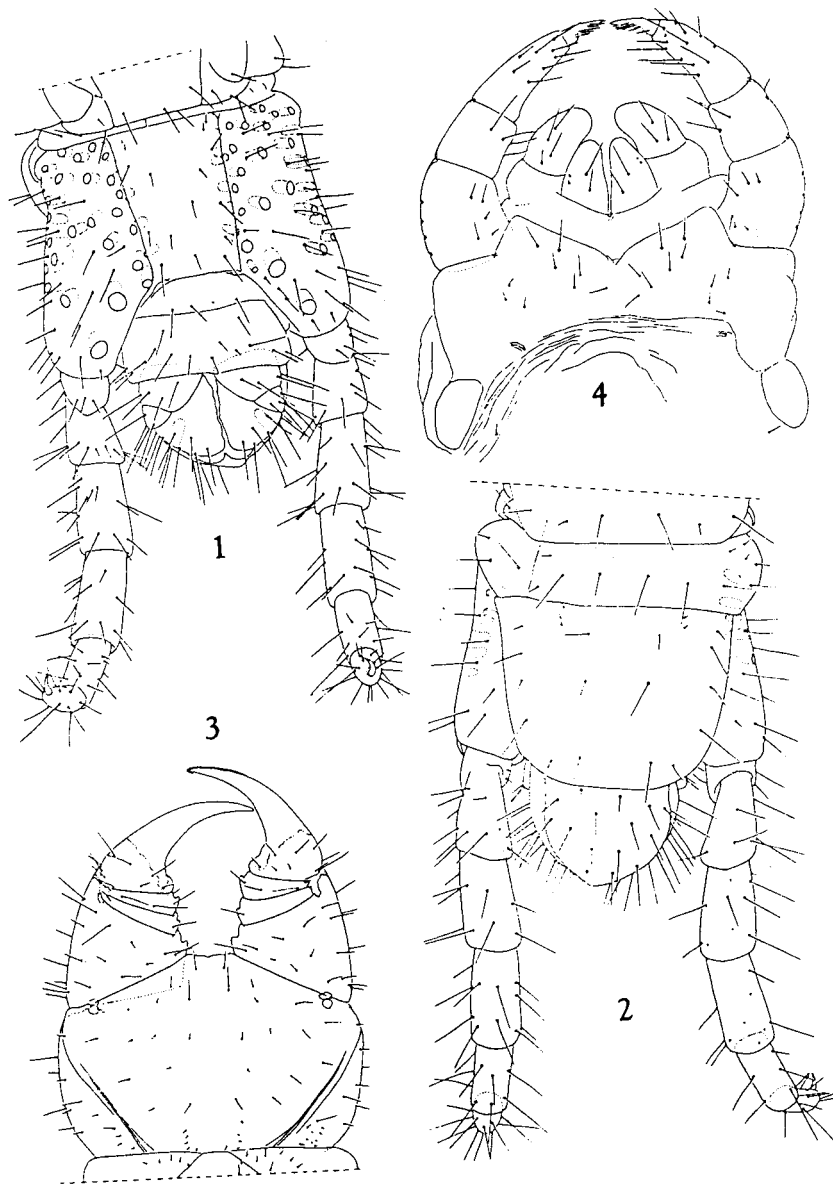

in USNM). Bland County: west side Walker Mountain along Va. Hwy. 670, 3 miles southeast of Mechanicsville, 1 March 1972, R. L. Hoffman and L. S. Knight, one female 31 mm long with 43 pairs of legs (USNM). Nelson County: "The Priest," 4 miles SSE of Montbello, pitfall at 3900 ft., 20 February 1992, two immatures with 39 pairs of legs and one immature with 41 (VMNH); 25 October-23 November, 1991, one immature female with 39 pairs of legs (VMNH); also one female 33 mm long with 39 pairs of legs, 20 January-28 February 1992 (VMNH).

In addition to the foregoing, we have seen three specimens in Dr. Crabill's personal collection which are probably referable to *E. urbicus* but which cannot be identified with certainty owing to poor condition of the slide preparations: Virginia: Alleghany County: Warm Springs Mountain, ca. 5 miles west of Clifton Forge at 3800 ft., 23 January 1953, R. L. Hoffman, one male, two females (REC 1574-76).

Diagnosis: *E. urbicus* belongs to the group of species in which the paraclypeal suture is complete and the lateral labromeres are not reticulated. It is similar to *E. monticolens* and *E. orestes* but differs by the characters stated in couplets 6 and 7 of the foregoing key.

Description (female from Mountain Lake): length 27 mm, width 1.0 mm, body with 41 pairs of legs.

Antennae approximately three times as long as cephalic capsule; pilosity of antennomeres similar on dorsal and ventral surfaces, basal four or five with large setae, those more distal with setae progressively smaller and more numerous apically. Apical article with about 20 claviform setae on the distal border internally and externally. Apex of this article with a group of about six very small setae, apparently not divided. Articles 2, 5, 9, and 13 provided with very small specialized setae similar to those on the apex of the 14th; 2nd with 1-3 setae dorsally and 1-2 ventrally, 5th with 1-2 and 2-3, 9th with 2 and 2-3, 13th with 2-3 and 1-2.

Cephalic sclerite slightly longer than wide. Entire surface of clypeus uniformly reticulate, chaetotaxy represented by 1+1 postantennal, 4+4 median transverse, and 1+1 prelabral setae; paraclypeal suture complete (Fig. 9). Labrum with a total of 12 "teeth," 8 on median arc and 2 on

→

Figures 5-9. *Escaryus urbicus* (female from Mountain Lake, Va.). 5. Left side of 1st maxillae, dorsal view. 6. Apex of right telopodite, 2nd maxillae, ventral view. 7. Dentate and pectinate lamellae of mandible. 8. Labrum. 9. Clypeus and basal antennomeres (a - paraclypeal suture). Figure 10. *Escaryus urbicus* (male from Mountain Lake, Va.). Last pedal segment and postpedal segments, ventral view.

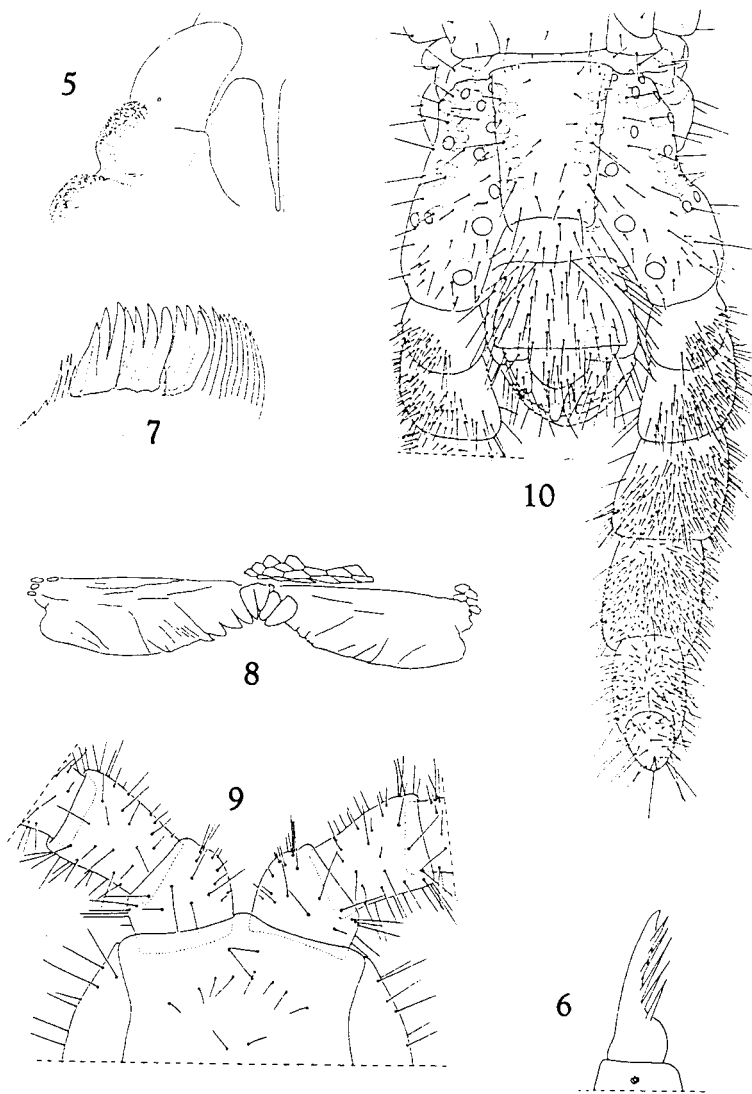

each lateral labromere. Form of labrum and relative size and shape of teeth shown in Figure 8.

Dentate lamella of mandible divided into three blocks with formula 3-3, innermost block subtended on mesal side by a group of 2-5 small hyaline fimbriae; pectinate lamella with 12 hyaline teeth (Fig. 7). Coxosternum of 1st maxillae lacking setae and bearing rudimentary palps; median prolongations of coxosternum subtriangular, well-developed and provided with 4+3 large setae. Telopodites biarticulate, first article with very small palp which slightly surpasses base of 2nd article (Fig. 5), latter with 4+3 setae on its ventral side and 2+1 sensory papillae on the dorsal (Figs. 4, 5). Coxosternum of 2nd maxillae with 10+10 setae arranged as shown in Figure 4. Apical claw of telopodite well developed and bipectinate with five pectines on ventral edge (Fig. 6) and six on dorsal. Shape and setation of telopodite articles as shown on Figure 4.

Prehensorial telopodites not surpassing anterior edge of cephalic sclerite when flexed. Internoapical border of trochanteroprefemur, femur, and tibia with dark-colored, well developed tooth. Tarsungula with a convexity basally on median side, but no true tooth present. Toxicodene with cylindrical calyx. Shape and setation of telopodites, coxosternum, and pleural sclerites as shown in Figure 3.

Pedal chaetotaxy similar throughout body length. Claws with squamose surface. Each claw ventrobasally with two large, subequal parungues, one anterior and one posterior; between these, close to posterior, a very much smaller third parunguis.

Sterna of segments 3 through 11 or 12 with shallow median longitudinal depressions, paler in color than rest of sternal surface. 3th-13th sterna with a small, semicircular sacculus centered on anterior edge.

Pretergum of ultimate pedal segment with visible suture between pleurites, presternum apparently medially divided. Tergum trapezoidal, basal width greater than length; form and setation as shown in Figure 2. Sternum notably (40%) longer than wide, lateral edges slightly convergent posteriad; form and setation as shown in Figure 1. Coxopleura with approximately 28+28 pores of irregular size distributed over ventral and lateral surfaces, among which are 2+2 much larger and very distinct pores located near posterior internolateral border of each coxopleuron; general shape, setation, and pore distribution as shown in Figures 1 and 2. Podomeres of ultimate legs slender, with sparse setation, their shape and chaetotaxy, and relative size of apical claw with respect to metatarsus shown in Figures 1 and 2.

Sternum of intermediate postpedal segment with slightly convex posterior edge, that of tergum strongly convex; posterior edge of genital segment I slightly concave on both sides of median line; basal segment of gonopod with 4 setae, distal with 2-3; chaetotaxy and shape of these segments represented in Figures 1 and 2.

Male (Mountain Lake, Virginia): Length 26 mm, width 0.9 mm, body with 41 pairs of legs. Structure agreeing closely with that of female except for posteriormost segments as noted below:

Sternum of last pedal segment slightly narrower (30% longer than wide as opposed to 40% in female); shape and chaetotaxy as in Figure 10. Coxopleura with about 26+26 irregular sized pores, their appearance as shown in Figure 10. Podomeres of ultimate legs very broad, ventrally invested with numerous short setae; dorsally with larger and fewer setae, form and setation of these legs represented in Figure 10.

Posterior border of 1st genital segment slightly convex. Gonopods with about seven setae on each basal article, seven on each distal (Fig. 10).

Variation: The largest specimen measured (female, Nelson County, Virginia) was 33 mm in length and 1.6 mm wide. Other adults are as small as 26 mm.

Over most of the known range, *E. urbicus* has either 41 or 43 pairs of legs. At one site in the Blue Ridge of Virginia, however, a local population shows a marked decrease (in four of five specimens) to 39. The number of known localities for this species is so far too few to warrant generalizations about geographic variation, but the accumulation of additional material will surely reveal data of interest in this respect.

Distribution: Northeastern United States (Map 2). Published records (Crabill, 1953, 1958) include Cambridge, Massachusetts; Syracuse and Ithaca, New York; Minnesota and Ohio, without locality; Baxter's Hollow, Sauk Co., Wisconsin; and Clifton Forge, Alleghany Co., Calf Mountain, Augusta Co., and Mountain Lake, Giles Co., Virginia. To these we now add the records for Nelson and Bland counties, Virginia, cited above under "Material", the latter representing the southernmost locality known for *urbicus*. Almost certainly, however, the species extends much further down the Appalachians at increasingly higher elevations.

Remarks: The descriptions of the female holotype by Meinert and of the likewise female holotype of the synonymous name *phyllophilus* by Cook & Collins did not provide information of diagnostic value at the species level. We did not redescribe the holotype of *urbicus* because its state of preservation obscured several important characters, and based the

present account on an unquestionably conspecific well-preserved female instead. The male of this species has not heretofore been recorded.

Escaryus orestes, new species
(Figures 11-26, Maps 2, 3)

Material: Male holotype (VMNH) 19 mm long with 43 pairs of legs, female paratype A (VMNH) 18 mm long with 45 pairs of legs, female paratype B (VMNH) 18 mm long with 45 pairs of legs, male paratype A (USNM) 17 mm long with 45 pairs of legs, male paratype B (MCZ) 17 mm long with 43 pairs of legs, also one immature 9 mm long with 43 pairs of legs; all from Whitetop Mountain, Washington County, Virginia, at an elevation of about 5400 feet ASL, 12 May 1988, L. A. Pereira and R. L. Hoffman leg.

Name: *Orestes*, the classical Greek word meaning "mountaineer," is bestowed in reference to the type locality.

Diagnosis: This species appears to be closely related to *E. monticolens*, but differs in surface sculpture of the tarsal claws and details of mouthparts as specified in key couplet 7.

Description: Male holotype 19 mm long, 0.8 mm wide, with 43 pairs of legs. Color of specimen newly-preserved in alcohol ochraceus-orange, cephalic sclerite and prehensorial segment of a slightly darker color.

Antennae about 3.2 times as long as cephalic sclerite, chaetotaxy similar on dorsal and ventral surfaces. Ultimate article with approximately 20 claviform sensory setae on external border and about 15 on internal. Apical extremity of this antennomere with about 7 very small, apparently undivided setae (Fig. 15). Articles 2, 5, 9, and 13 with very small specialized setae similar to those on apex of ultimate antennomere, those on ventral side located in an internal lateroapical area, those on dorsal occupy external lateroapical and median apical positions. Distribution of setae (ventral/dorsal): 2nd, 1/2, 5th, 2/1-2, 9th, 1-2/2-4, 13th, 2/3-4. Ventral setae of 5th article, Figure 26.

Cephalic sclerite slightly longer than broad, its shape and setation as shown in Figure 20. Entire surface of clypeus uniformly reticulated; 1+1 postantennal, 4+4 medial, and 1 prelabral setae present (Fig. 21). Labrum with a total of 27 dental lobes, the outermost on lateral labromeres very small and with very acute tips (Fig. 19).

Dentate lamella of mandible divided into three blocks with formula 4-4-4, innermost block subtended on mesal side by a group of 4-5 hyaline

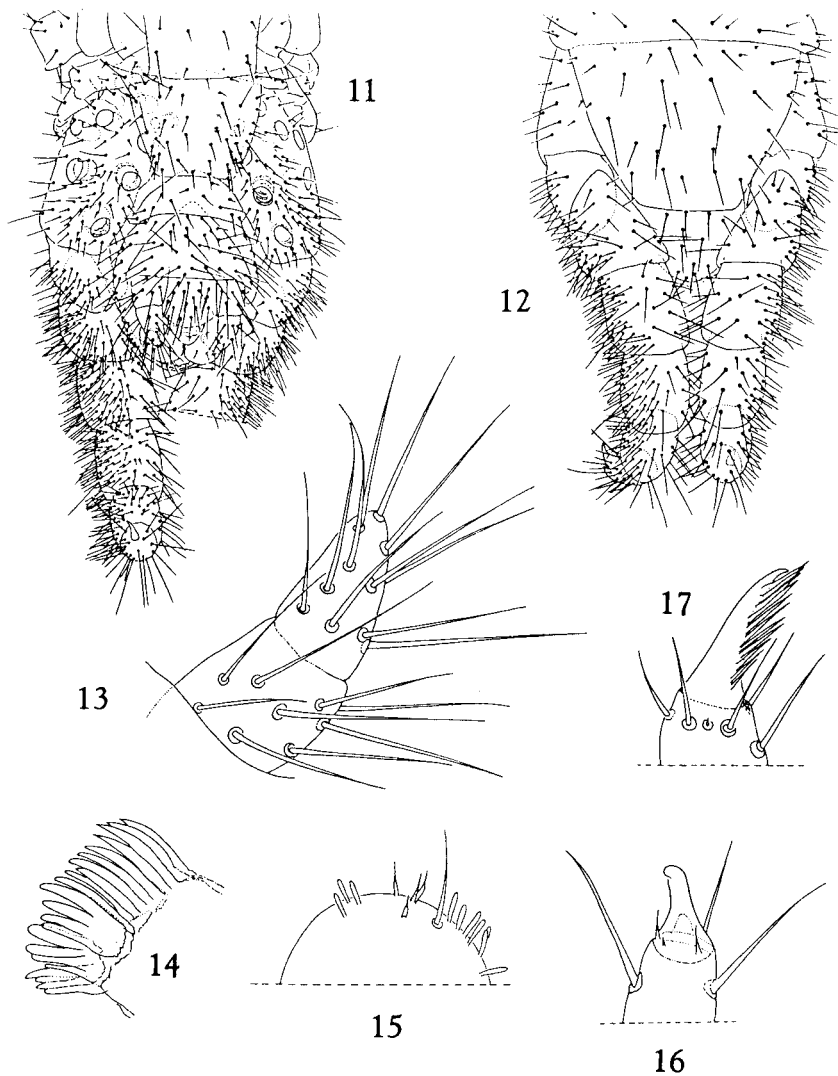

Figures 11-17. *Escaryus orestes* (male holotype). 11. Last pedal segment and postpedal segments, ventral view. 12. The same segments, dorsal view. 13. Right gonopod, ventral view. 14. Dentate and pectinate lamellae of right mandible. 15. Apex of ultimate right antennomere showing specialized and claviform setae. 16. Apex of 10th right leg, ventral view. 17. Apex of right telopodite of 2nd maxillae, ventral view.

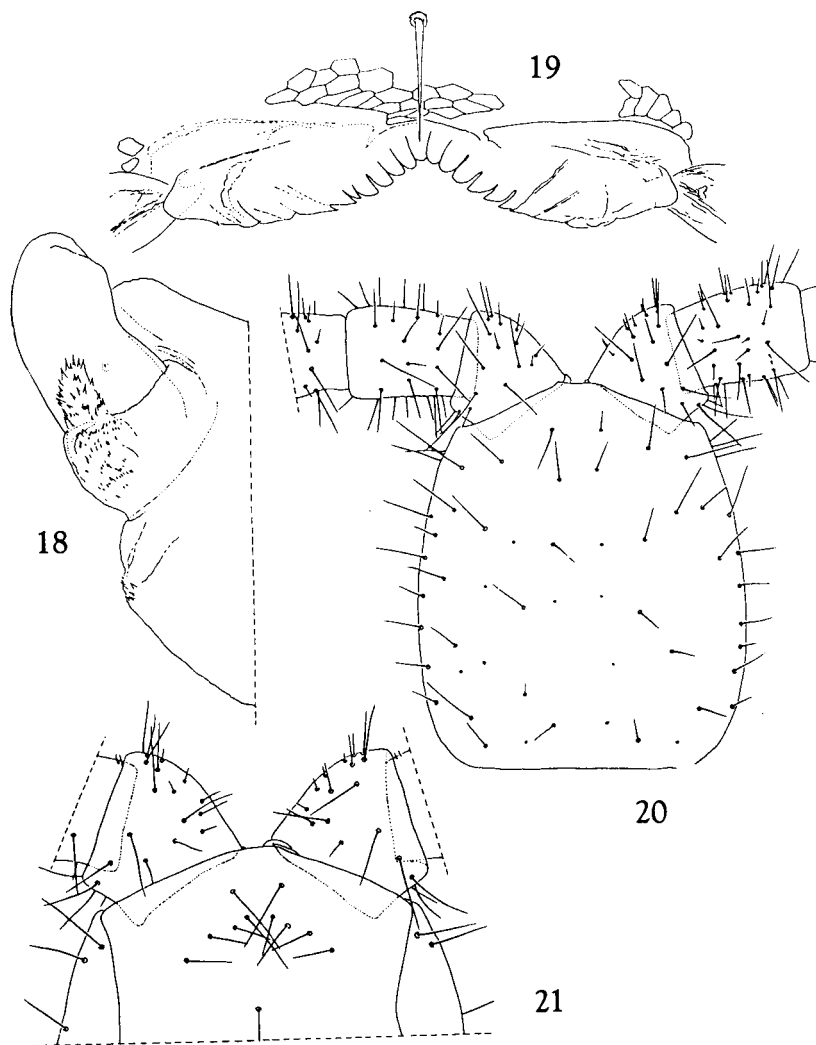

Figures 18-21. *Escaryus orestes* (male holotype). 18. Left side of 1st maxillae, ventral view. 19. Labrum. 20. Cephalic sclerite and basal antennomeres. 21. Clypeus.

fimbriae of variable size; pectinate lamella with 10-12 hyaline teeth (Fig. 14). Coxosternum of maxillae I without setae and with rudimentary, almost nonexistent, palps, recognizable only by surficial characters similar to those of telopodital palps (Fig. 18); median prolongations of coxosternum subtriangular, well-developed and provided with 2+2 large setae. First article of telopodite with very small palps, distal article with 3+2 setae (Figs. 18, 24). Coxosternum of maxillae II with 9+8 setae located as shown in Figure 24. Apical claw of telopodite well-developed, bipectinate, with 6 dorsal and 10 ventral pectines (Fig. 17).

Closed telopodites of prehensors extend approximately as far forward as anterior margin of cephalic sclerite. Basal plate with 8+9 large and small setae. Each prehensomere with a basal tooth, those of femur and tarsungula much smaller than the others. Toxicodene well developed, with cylindrical calyx. Chaetotaxy of coxosternum and telopodites as shown in Figure 22.

Pedal chaetotaxy uniform throughout length of body, except on last pair of legs. Surface of tarsal claws smooth. Each claw with two ventrobasal parungues, an anterior and a much smaller posterior, with a third still smaller very close to base of the latter, all three similar to setae elsewhere on legs in color and shape (Fig. 16).

Sterna of segments 3-12 with a small, very shallow median longitudinal depression similar in color to rest of surface; sterna of segments 4-12 with a small semicircular sacculus centered on anterior edge.

Pretergum of last pedal segment without suture between its pleurites, presternum medially divided. Tergum trapezoidal, its base much wider than its length, posterior edge approximately straight, shape and setation shown in Figure 12. Sternum slightly broader than long, lateral sides convergent posteriad, posterior edge weakly concave, vestiture present as scattered moderate to large setae of the form shown in Figure 11. Coxopleural pores 15+15, opening on lateral and ventral surfaces only; setation consisting of large and small setae, the latter being concentrated in a ventroapical area (Figs. 11, 12). Podomeres of terminal legs broad, ventrally with numerous setae externomedially, similar setae occur on lateroexternal surface; ultimate article with a weakly developed apical claw; form and chaetotaxy of these podomeres shown in Figures 11 and 12.

Posterior edge of tergum of intermediate postpedal segment convex, that of sternum concave; genital segment I with posterior border nearly straight; basal article of gonopods with 9-10 setae, distal with 11 (Fig. 13). Penis with 1+1 setae dorso-apically. Shape and chaetotaxy of these seg-

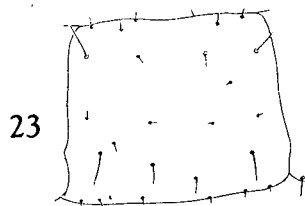
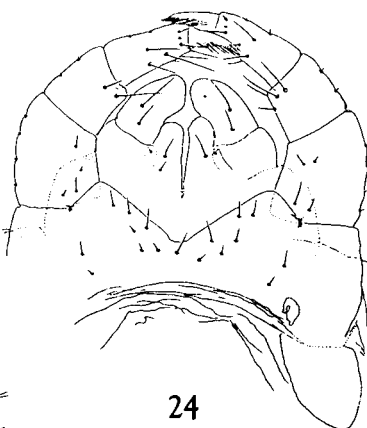
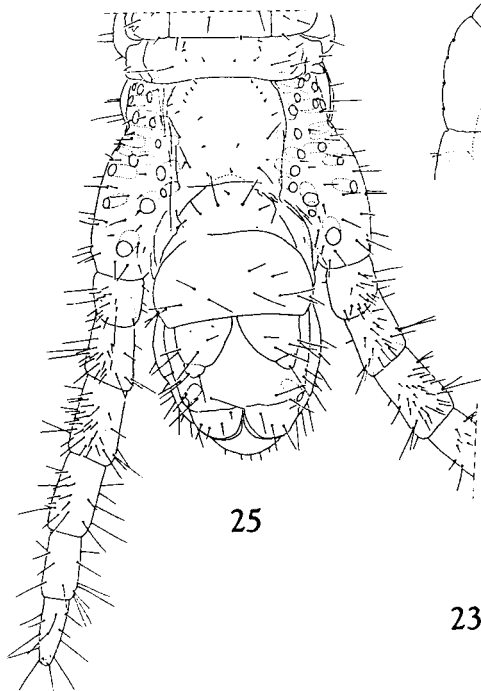
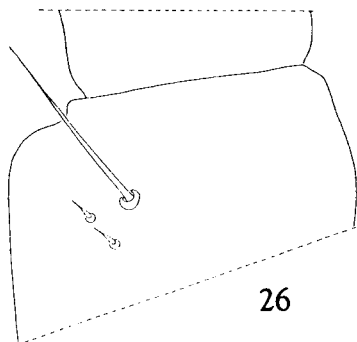
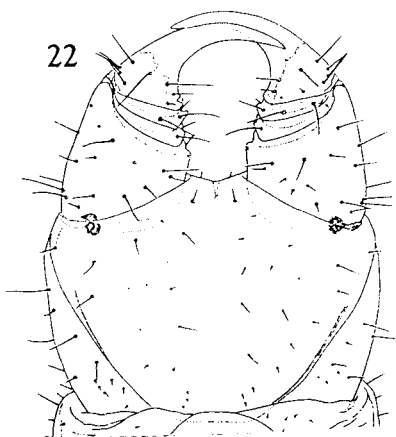

ments illustrated in Figures 11 and 12.

Male paratypes: Characters agreeing generally with those of holotype except for presence of 1+1 prelabral clypeal setae instead of 1, and in that paratype A has 45 pairs of legs instead of 43.

Female (paratype A): Length 18 mm, width 0.8 mm; 45 pairs of legs. Characters concurring with those of male except for differences in the posteriormost segments.

Sternum of ultimate pedal segment with sides almost parallel, setation represented by scattered setae of medium to large size Coxopleura with 20+19 pores; setation consisting of dispersed moderate to large setae. Terminal legs with slender podomeres, ventral surface of trochanter, prefemur, femur, and tibia with small setae, setae relatively larger and less numerous on dorsal side (shape and chaetotaxy of this segment shown on Figure 25).

Tergum of intermediate postpedal segment with slightly convex posterior edge, that of sternum slightly concave. Basal article of gonopods with 4-5 setae, distal with 1-2, as shown in Figure 25.

Female paratypes **B** and **C**: Structural features agreeing generally with those of paratype A as described above.

Distribution: This species is known only from the type locality and from Grayson Highlands State Park, 4900 ft. on Haw Orchard Mountain, where one female (45 pairs of legs) was collected by a pitfall trap in mixed *Picea - Betula* woods, 2-17 October, 1990 (VMNH). This site is in Grayson County, Virginia, approximately 10 km northeast of the type locality.

Remarks: The type specimens were collected in the dark moist soil and litter beneath trees of the genera *Picea* and *Betula*, at an elevation of about 5200 feet and in company with those of *E. cryptorobius*. These species apparently are stenothermic, surface-active only during the colder months of the year and retreating deeply into the substrate during warmer periods.

←

Figures 22-24. *Escaryus orestes* (male holotype). 22. Prehensorial segment. 23. Sternum of 3rd pedal segment. 24. 1st and 2nd maxillae. Figure 25. (Female paratype.) Ultimate pedal segment and postpedal segments, ventral view. Figure 26. (Male holotype.) Left 5th antennomere, ventral view.

Escaryus monticolens Chamberlin
(Figures 27-37, Map 1)

Escaryus monticolens Chamberlin, 1947, Pan-Pacific Ent., 23(1): 37. Female holotype (USNM) from Mill Creek Canyon at 7,500 ft., Davis County, Utah, A. M. Woodbury.—Crabill, 1961, Ent. News, 72: 70.

Material: Only the holotype from Mill Creek Canyon, Utah, has been examined.

Diagnosis: This species is similar to *E. orestes* in number of coxal pores, body size, and number of pedal segments, but differs in the character states specified in couplet 7 of the preceding key to species.

Description: Holotype female, 18 mm long, 0.9 mm in width, with 43 pairs of legs.

Antennae approximately 2.9 times as long as cephalic sclerite, pilosity of antennomeres similar on dorsal and ventral surfaces. Ultimate article with about 17 claviform setae on external border, and about 12 on internal; apex with about 5 very small and apparently simple specialized setae. Articles 2, 5, 9, and 13 with 1 to 3 setae similar to those anterior dorsally and ventrally. Cephalic sclerite slightly (about 10%) longer than broad, its setation and shape as shown in Figure 36. Entire surface of clypeus uniformly reticulated, chaetotaxy: 1+1 postantennal, 5+4 medial transverse, and 1+1 prelabral setae. Paraclypeal suture complete (Fig. 35). Labrum with 18 marginal dentations, 11 on median arc, the others (4+3) on the lateral labromeres, the outermost very small with attenuated apex (Fig. 32).

Dentate lamella of mandible divided into three blocks with formula 3-4-4, innermost block subtended on mesal side by a group of three hyaline fimbriae; pectinate lamella with 18 hyaline teeth (Fig. 33).

Coxosternum of 1st maxillae lacking setae, its palps rudimentary; median prolongation well-developed, subtriangular, with 4+3 setae. Palps of first article of telopodite very poorly developed, not extending distad to midlength of 2nd article, latter with 3+5 setae (Fig. 37). Coxosternum of 2nd maxillae with 11+10 setae dispersed as shown in Figure 37. Apical claw of telopodite well developed, bipectinate, ventral edge with seven hyaline pectines (Fig. 27). Shape and chaetotaxy of telopodite articles as shown in Figure 37.

Closed telopodites of prehensors not surpassing anterior edge of cephalic sclerite. Internoapical surface of trochanteroprefemur and femur

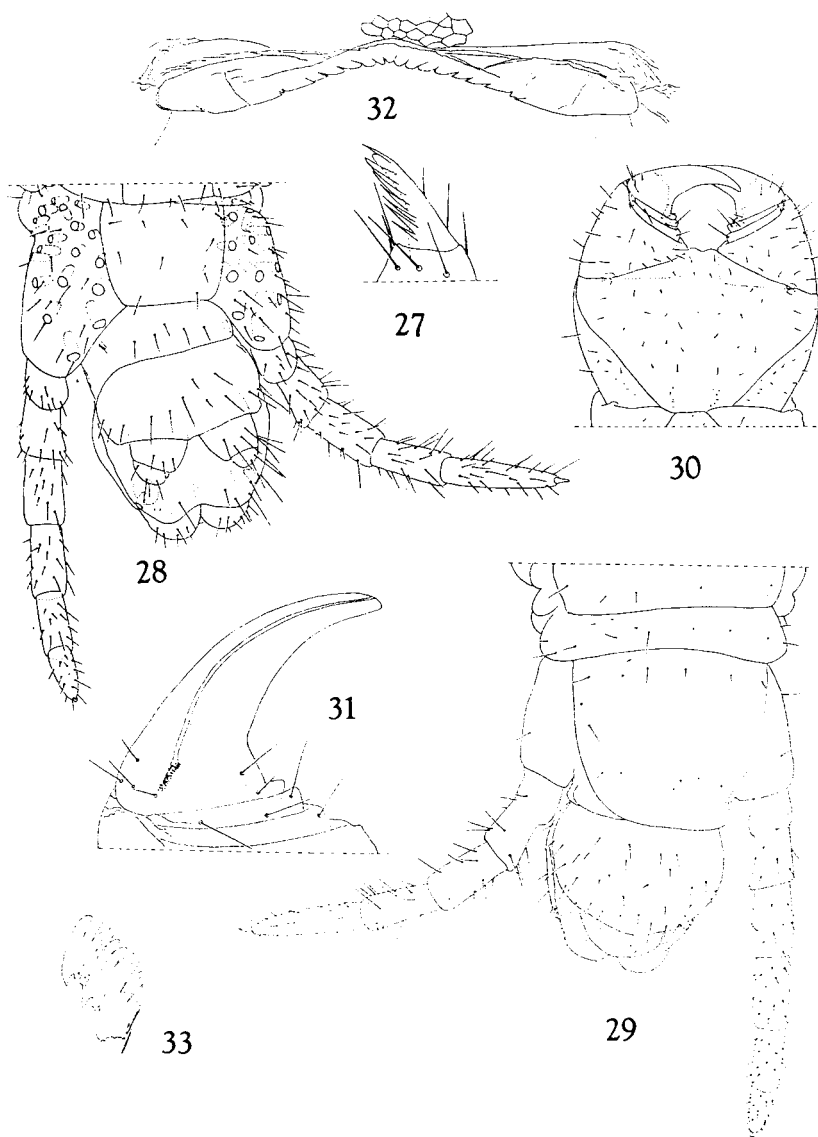

Figures 27-33. *Escaryus monticolens* (female holotype). 27. Apex of right telopodite of 2nd maxillae, dorsal view. 28. Ultimate pedal segment and postpedal segments, ventral view. 29. The same segments, dorsal view. 30. Prehensorial segment, ventral view. 31. Apex of right prehensor, ventral view. 32. Labrum. 33. Dentate lamella of mandible.

with poorly developed tooth or tubercle. Calyx of toxicodene cylindrical (Fig. 31). Shape and setation of telopodites, coxosternum, and pleurites shown in Figure 30.

Setation of legs constant throughout length of body. Claws with squamous surface sculpture, each claw with two principal ventrobasal parungues of similar size, one anterior and one posterior, a third much smaller parunguis near base of the posterior.

Sterna without pores; anteriormost with shallow median depression, colored like rest of sternal surface. Anterior edge of 4th-12th sternites with small median semicircular sacculus.

Pretergum of ultimate pedal segment with visible suture between pleurites; tergum (Fig. 29) trapezoidal, approximately as long as its basal width. Sternum trapezoidal, wider at anterior base than long, lateral edges slightly convergent posteriad, surface with sparse setae (Fig. 28). Coxopleura with about 18-20 pores laterally and ventrally, their distribution and shape as shown in Figure 29. Terminal legs with slender podomeres, sparsely setose, setae more abundant on ventral surface than dorsal. General appearance of these legs shown in Figures 28 and 29.

Posterior edge of sternum of intermediate postpedal segment nearly straight, that of tergite convex; genital segment I with posterior edge slightly convex medially and shallowly concave on each side; basal article of gonopods with about six setae, distal with three. Form and setation of postpedal segments as shown in Figures 102 and 103.

Male: So far unknown for this species.

Distribution: *Escaryus monticolens* is known only from the type locality, a canyon in the Wahsatch foothills east of Salt Lake City.

Remarks: The original description of this species was based on a single female specimen, and included neither illustrations nor information on many characters of diagnostic value. The foregoing account of the same specimen mitigates those shortcomings.

Chamberlin asserted that the labrum had 15 teeth, but we have observed 18. He stated further "First maxillae with palpi having well developed lappets": we have observed that the coxosternum has only rudimentary palps and those of the telopodites are poorly developed, not attaining midlength of 2nd article. He remarked also that the mandibular dentate lamella had 3-3-4 teeth whereas we counted 3-4-4.

Our figures 28, 29, and 37 do not represent the actual structure of the parts shown, which are somewhat deformed by the preservation both in alcohol and in the microscope preparation.

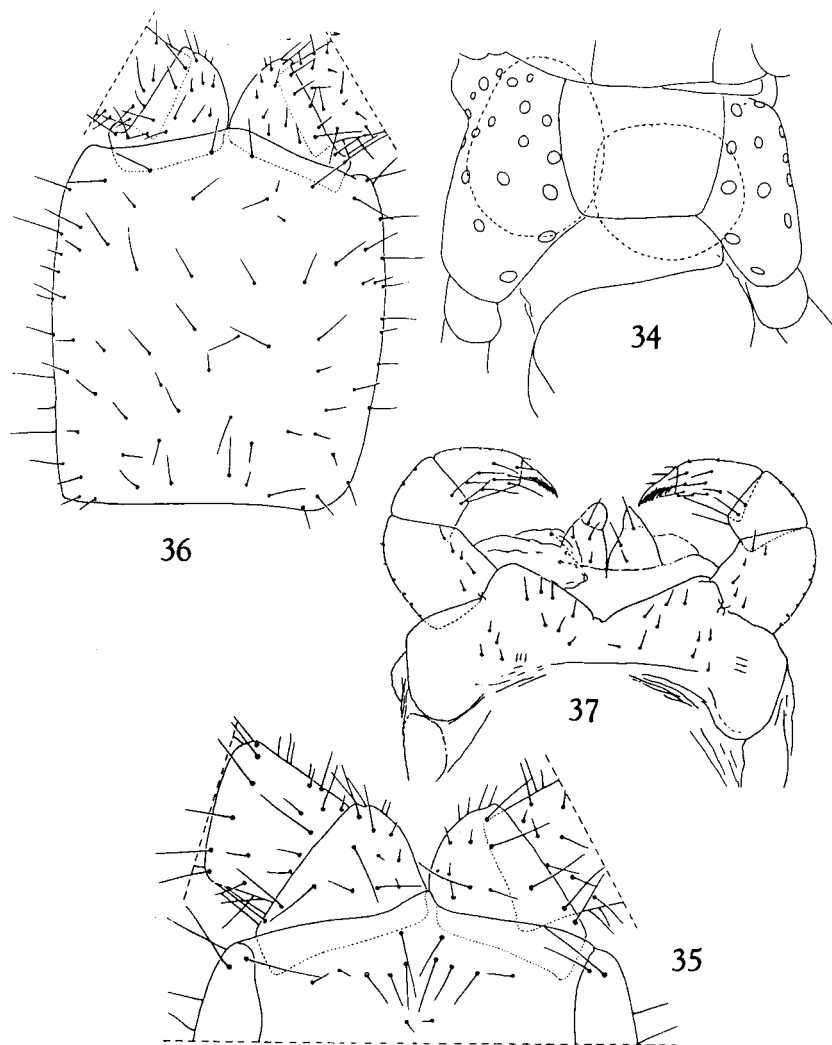

Figures 34-37. *Escaryus monticolens* (female holotype). 34. Last pedal segment, showing internally spermathecae exposed during preparation (dashed lines). 35. Clypeus and basal antennomeres. 36. Cephalic sclerite. 37. 1st and 2nd maxillae, ventral view.

Escaryus cryptorobius, new species
(Figs. 38–83, Maps 2, 3)

Material: Male holotype (VMNH), 19 mm long with 35 pairs of legs; male paratype (USNM) 11 mm long with 31 pairs of legs; two female paratypes (VMNH), both 10 mm long, one (paratype A) with 33 pairs of legs, the other (paratype B) with 35; two juvenile males (VMNH), one 10 mm long with 35 pairs of legs, the other 7.5 mm long with 31, all from Whitetop Mountain, ca. 5400 ft. ASL, Grayson County, Virginia; R. L. Hoffman leg. 15 December 1984 (ex Berlese-sample); also one female topoparatype (USNM) 17 mm long with 35 leg pairs (example A) and another female (MCZ) 15 mm long with 33 leg pairs, same locality, L. A. Pereira and R. L. Hoffman leg. 12 May 1988. Two males 17 mm long with 37 segments from "The Priest", 3900 ft., 4.5 miles southeast of Montebello, Nelson County, Virginia, 20 January–28 February 1992 (VMNH, *not* paratypes); two immatures (?female) 5 mm long with 31 segments from Buffalo Mountain, 3500 ft., 3 miles south of Willis, Floyd County, Virginia, 2 July 1992 (VMNH, *not* paratypes).

Name: from the Greek *kryptos* + *orobios*, literally "secretive mountain dweller."

Diagnosis: This species is distinguished from most others by the reduced number of legs (31–37 pairs) and small size (maximum length 19 mm), and from the similar *E. paucipes* by the greater number of coxopleural pores and other details mentioned in couplet 4 of the preceding key.

Description: Adult male holotype, length 19 mm, maximum width 1.0 mm; body with 35 pairs of legs. Color of preserved specimen ochraceous-orange, with head and prehensorial segment slightly darker.

Antennae about 4.3 times longer than the cephalic sclerite; chaetotaxy similar on ventral and dorsal surfaces of antennomeres (shape and distribution of the setae as shown in Figure 38). Terminal article with about 19–27 claviform sensory setae on the external border and about 17–20 on the internal. Distal extremity of this antennomere with about

→

Figures 38–46. *Escaryus cryptorobius* (male holotype). 38. Left antenna, ventral view. 39. Apical right antennomere, ventral view. 40. Apex of left apical antennomere. 41. 2nd left antennomere, ventral view. 42. 9th left antennomere, dorsal view (a, b, c, three kinds of specialized setae). 43. 13th right antennomere, dorsal view. 44. Cephalic sclerite, ventral view. 45. The same, dorsal view. 46. Prehensorial segment, ventral view.

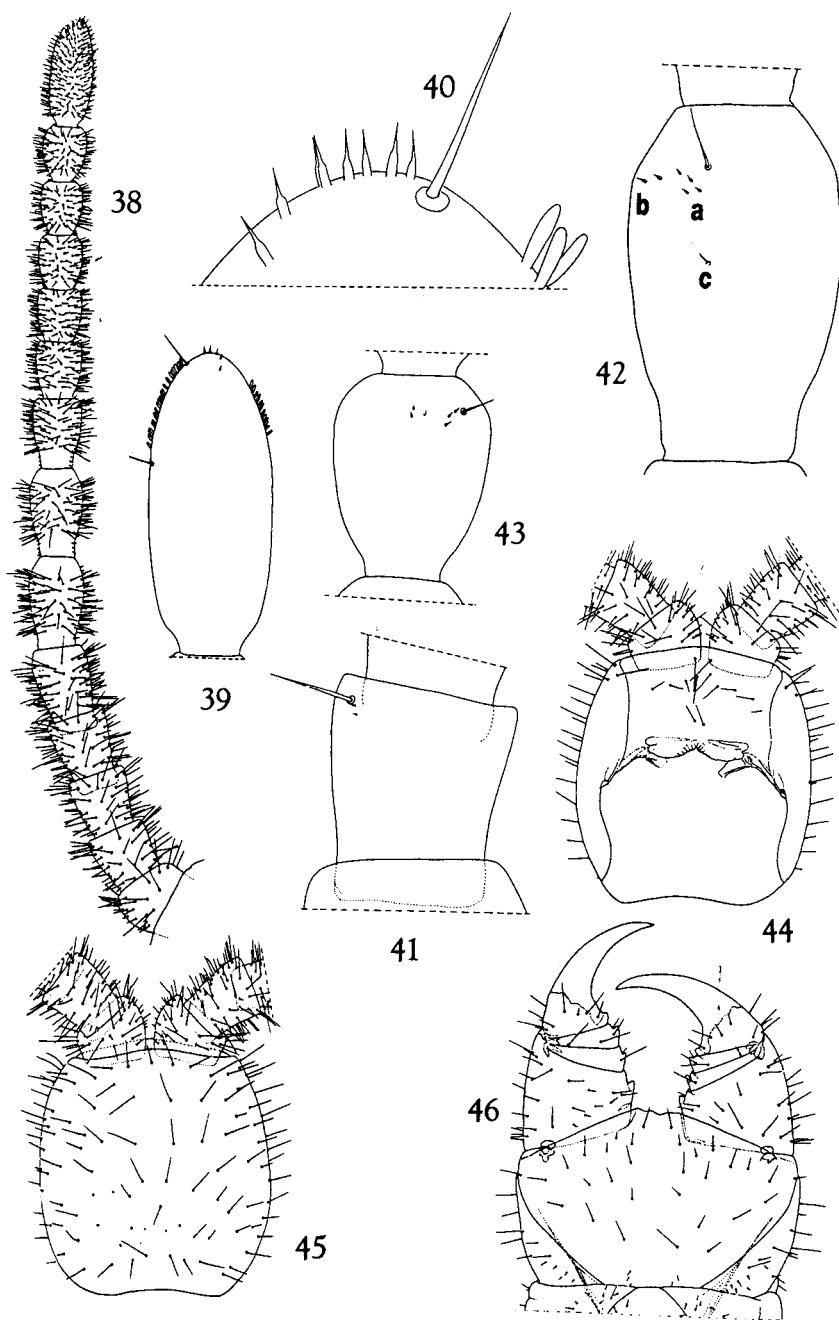

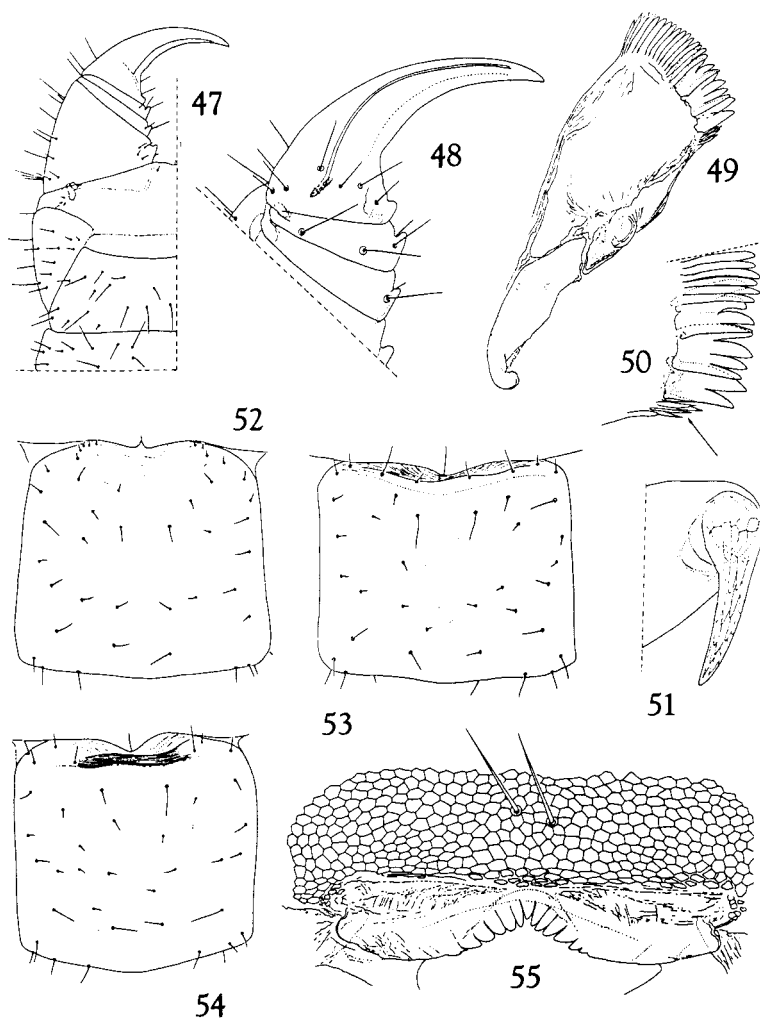

Figures 47-55. *Escaryus cryptorobius* (male holotype). 47. Left side of prehensors, ventral view. 48. Apex of right prehensorial telopodite, ventral view. 49. Mandible. 50. Detail at apex of mandible. 51. Apical claw of left 9th leg, anterodorsal view. 52-54. Sterna of segments 6, 7, and 9. 55. Labrum.

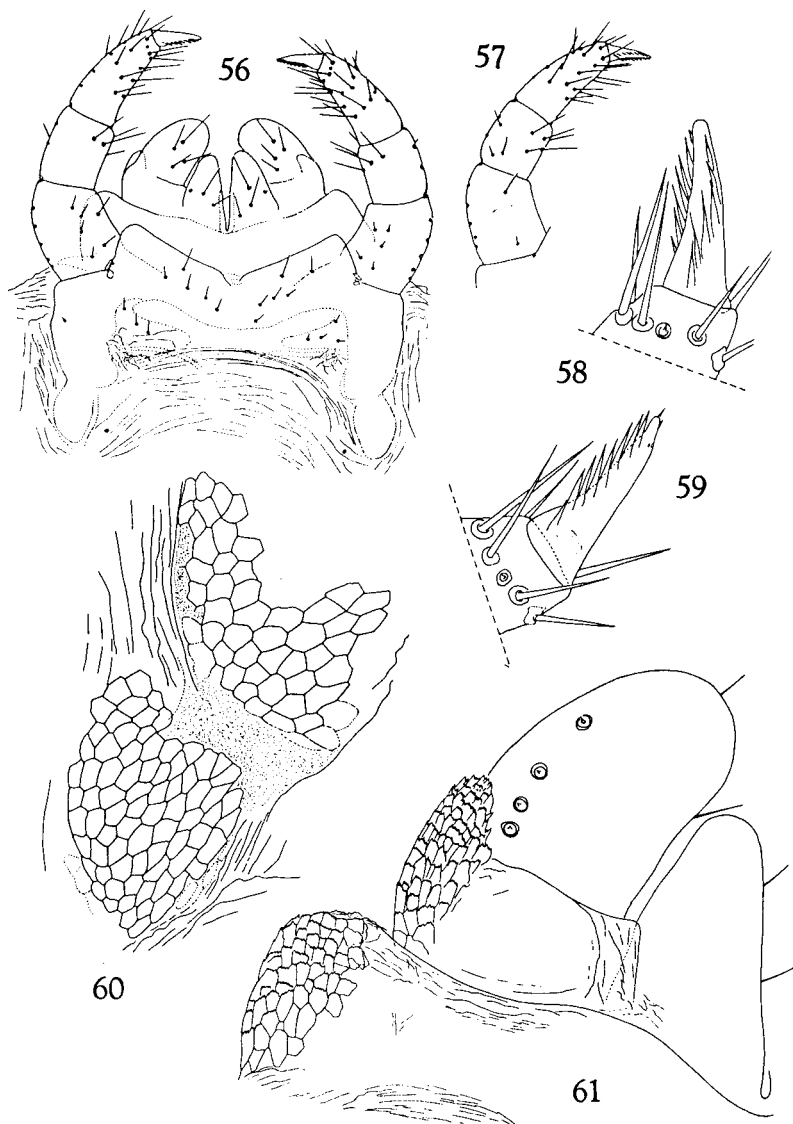

Figures 56-61. *Escaryus cryptorobius* (male holotype). 56. 1st and 2nd maxillae. 57. Left telopodite of 2nd maxillae. 58. Apex of right telopodite of 2nd maxillae, dorsal view. 59. The same, ventral view. 60. Detail of right lateroposterior sector of 2nd maxillae. 61. Right side of 1st maxillae, dorsal view.

eight very small setae which are not apically divided (Fig. 40). Dorsal and ventral surfaces of articles 2, 5, 9, and 13 with very small specialized setae restricted on ventral side to an internal latero-apical area very similar to those of the apex of the ultimate article; 2nd article with two setae, 5th, 9th, and 13th with either two or three. Specialized setae on dorsal side of segments 2, 5, 9, 13 located in external lateroapical and medioapical areas and are represented by three different types *a*, *b*, and *c* (Fig. 42). Type *a* setae are very similar to those at the apex of the 14th antennomere; type *b* are similar to *a* but are much darker (ochraceous) in color; type *c* has a different shape from the preceding, obviously much larger, similar in color to setae on 14th article. Setae *a* and *c* occupy the apicomedian part of the specified articles, whereas type *b* setae occur on the external apicolateral region. All four numbered articles have a single type *c* seta (except on the 13th of the right antenna); 2nd with two setae *a*; 5th with two or three setae *a*; 9th with three or four type *a* and two or three type *b*; 13th with three or four type *a* and three or four type *b*.

Cephalic sclerite 10% longer than wide, its shape and chaetotaxy as in Figure 45. Entire surface of clypeus uniformly reticulate (no plagulae present), chaetotaxy represented by 1+1 postantennal, 4+5 median transverse, and 1+1 prelabral setae (Fig. 44). Median labromere with 11 teeth, laterals with 2+1 teeth (Fig. 55).

Dentate lamella of mandible divided into three blocks with formula 4-2; innermost block subtended on mesal side by a basal cluster of five hyaline fimbriae of variable size (indicated by an arrow on Figure 50); pectinate lamella with 19 hyaline teeth. Coxosternum of 1st maxillae without setae, palps strongly reduced and only recognizable by the characteristics present on its surface similar to those of the telopodital palp (Fig. 61); median projection of coxosternum subtriangular, well developed, provided with 2+3 large setae and 1+1 much smaller setae. Basal article of telopodite with very small palp, distal with 4+4 setae on ventral side and 4+3 sensory papillae on the dorsal (Figs. 56 and 61). Coxosternum of 2nd maxillae with 9+10 setae distributed according to Figure 56. Apical claw of telopodite well developed and bipectinate, dorsal edge with six pectines and ventral with eight (Figs. 58 and 59 respectively). Shape and chaetotaxy of telopodite as in Figures 56 and 57.

→

Figures 62-67. *Escaryus cryptorobius* (male holotype). 62. Claw of right 26th leg, anteroventral view. 63. Last pedal and postpedal segments, dorsal view. 64. The same segments, ventral view. 65. Schematic view of sternum of last pedal segment and coxal organs. 66. Apical claw of last right leg. 67. Detail of a coxal organ.

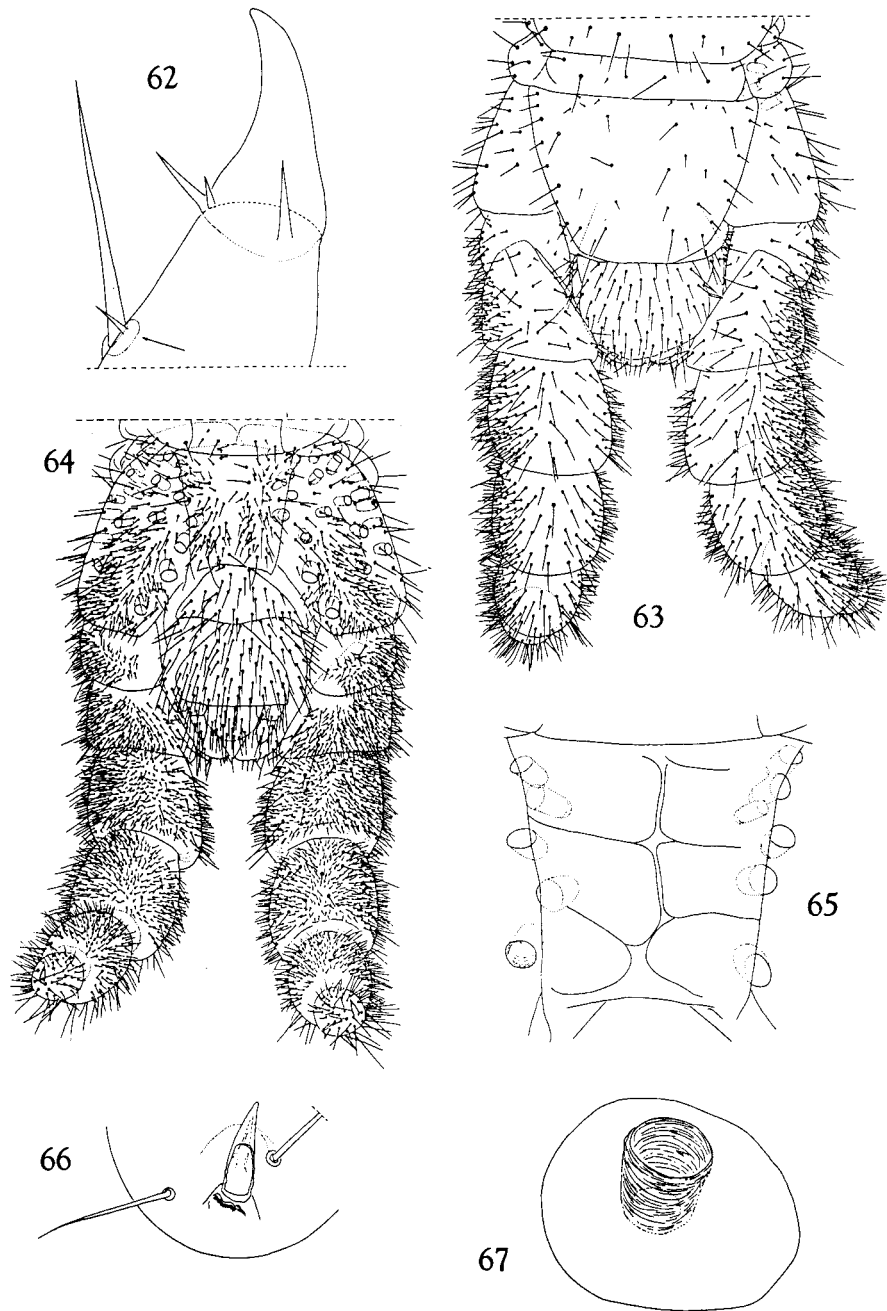

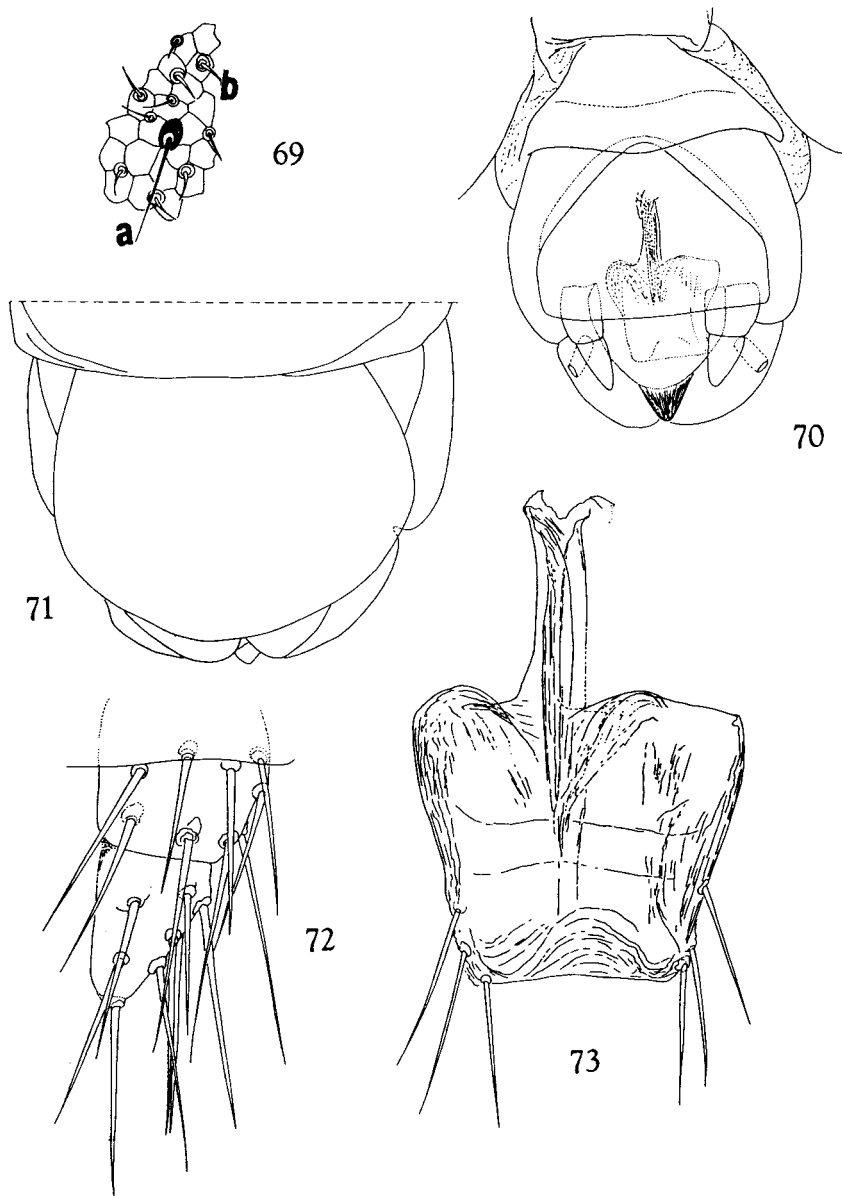

Figures 69-73. *Escaryus cryptorobius* (male holotype). 69. Detail of integument and setae of last pair of legs, ventral view (**a**, large darkly pigmented setae, **b**, small setae without pigment). 70. Schematic view of postpedal segments, ventral view. 71. The same segments, dorsal view. 72. Left gonopod, ventral view. 73. Penis, dorsal view.

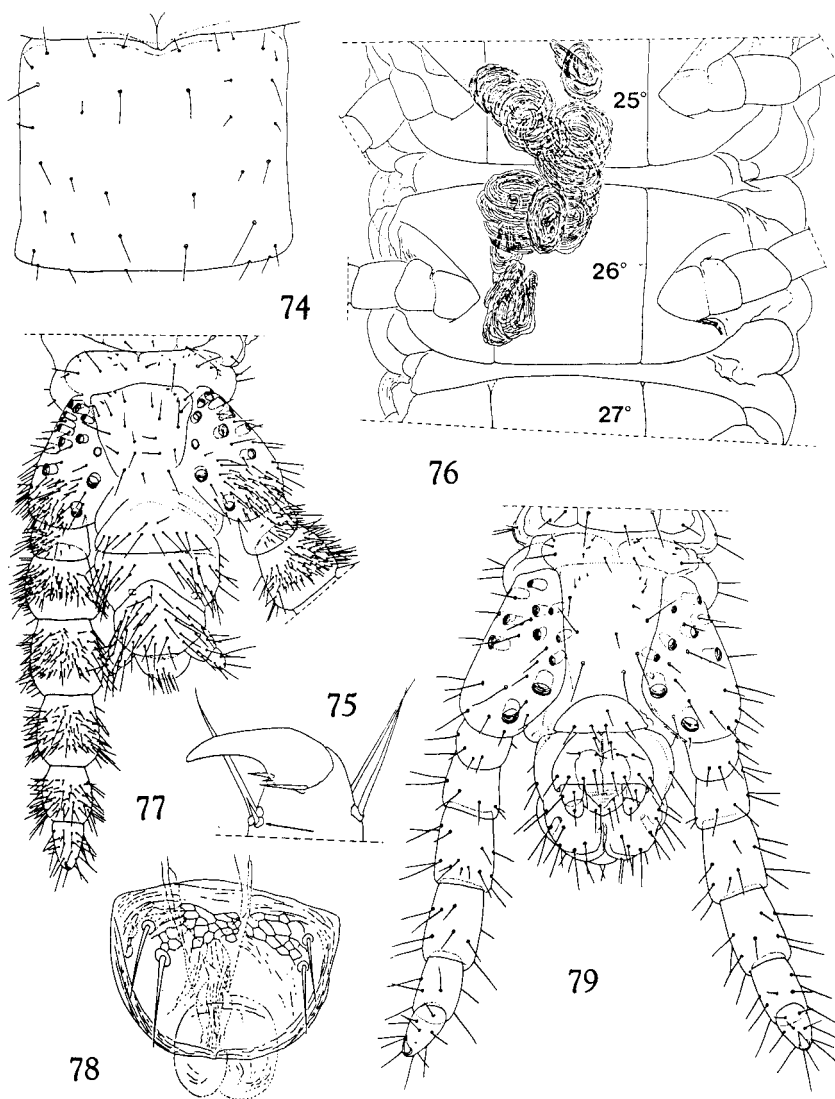

Figures 74-79. *Escaryus cryptorobius* (male holotype). 74. Sternum of 12th segment. 75. Claw of 12th right leg, anteroventral view. Figures 76-78. *Escaryus cryptorobius* (male paratype). 76. Segments 25 and 26 showing spermatozoa internally. 77. Last pedal segment and postpedal segments, ventral view. 78. Penis, dorsal view. Figure 79. *Escaryus cryptorobius* (juvenile male A). Last pedal segment and postpedal segments, ventral view.

Closed telopodites of prehensors extending forward as far as anterior edge of cephalic sclerite. Basal sclerite with 13+13 setae (Fig. 47). Trochanteroprefemur, femur, and tibia of telopodite each with well developed tooth on apical part of internal surface; tarsungula with clearly visible tooth on basal part of internal border. Calyx of toxicodene short and cylindrical (Fig. 48). Chaetotaxy of coxosternum and telopodites as shown in Figures 46 and 47.

Chaetotaxy of legs similar throughout length of body except for last pair. Tarsal claws with squamosely reticulate surface (Fig. 51). Each claw provided on its ventrobasal part, with a large anterior parunguis and a smaller posterior, internally and very close to posterior occurs still a third much smaller than the latter (Fig. 62); all three parungues concolorous with setae of podomeres and like them terminate in a very fine point. A very small seta (shown by an arrow on Figs. 62 and 75), largest on anterior legs and diminishing posteriad, occurs in a ventro-posterior position on the tarsus of all legs.

Sterna of segments 3 to 11 provided with a small, very shallow longitudinal median depression colored like rest of the surface (Figs. 52-54). Anterior border of sterna 5 to 14 with median semicircular sacculus, associated on 5th-14th sterna with a chitinous internal thickening (Figs. 52-54, 74).

Pretergum of last pedal segment separated from pleurites by sutures, presternum medially divided. Tergum trapezoidal, anterior base much wider than length, posterior border distinctly convex (shape and pilosity as shown in Fig. 63). Sternum approximately as wide as long at base, lateral edges converging posteriad, distal edge slightly concave (shape and pilosity as shown in Figure 64). Coxopleural pores 27+23, distributed over ventral and lateral sides only, pilosity containing both small and large setae, latter differing from others in size and much darker color (Figs. 63 and 64). Podomeres of terminal legs notably incrassate, their setation similar to that of coxopleura; apex of distalmost podomere with poorly developed claw; form of podomeres and their chaetotaxy as represented on Figures 63, 64, and 69.

Posterior border of both sternum and tergum of intermediate postpedal segment convex; posterior border of genital segment I weakly convex; basal article of gonopod with 9 setae, distal with 7 or 8 (Figs. 64 and 72). Penis with 3+3 setae distally on dorsal side (Fig. 73). All setae of these segments similar in size and coloration to the large setae present on coxopleura and legs of ultimate pedal segment. Form and chaetotaxy of

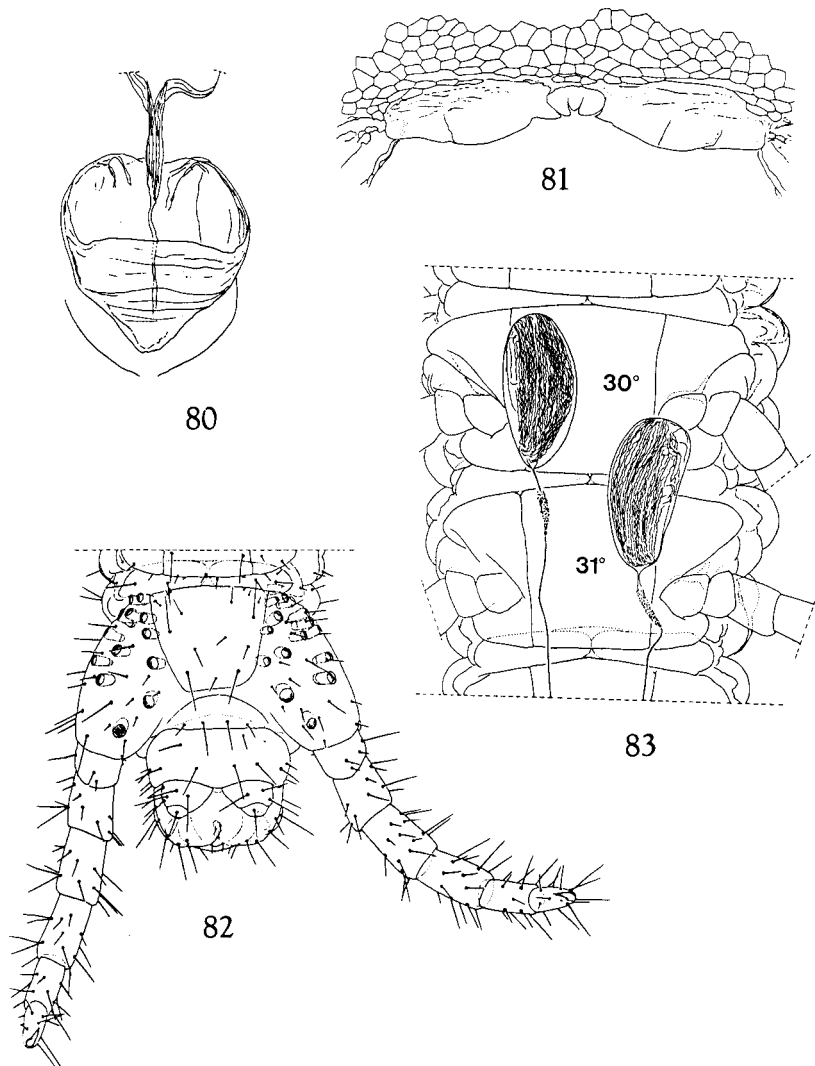

Figures 80-83. *Escaryus cryptorobius* (juvenile male A). 80. Penis, dorsal view. 81. Labrum. Figures 82-83. *Escaryus cryptorobius* (female paratype A) -82. Last pedal segment and postpedal segments, ventral view. 83. Segments 30 and 31, showing spermathecae internally.

these segments shown in Figures 63, 64, 70, and 71.

Paratype: Male (adult as indicated by the presence of spermatozoa in the body) in the *maturus junior* stage, length 11 mm, width 0.5 mm; 31 pairs of legs. Differing from holotype as follows:

Antennae shorter relative to length of cephalic sclerite (only 3.6 times as long) and antennomeres with relatively fewer setae; ultimate article with fewer claviform and specialized setae at apex; articles 2, 5, 9, and 13 with fewer specialized setae.

Cephalic sclerite and clypeus with fewer setae (the latter with only 4+4).

Median prolongation of coxosternum of 1st maxillae with fewer setae (1+1 large and 1+1 smaller); 2nd article of telopodite less pilose (2+2 setae), and sensory papillae absent from dorsal side. Coxosternum of 2nd maxillae with fewer setae (5+5); apical claw of telopodite with fewer pectines (4+5 on dorsal edge and 6 on ventral) telopodites with fewer setae on both dorsal and ventral surfaces.

Prehensors and legs with fewer setae. Longitudinal median depression and anterior median sacculus not visible; internal thickened chitinous outline visible only at median part of anterior border of segments 8 - 12.

Ultimate pedal segment less pilose, especially on sternum, where only large setae are present. Coxopleural pores less numerous (13+13) (Fig. 77). Pilosity of postpedal segments reduced, gonopods with only 7-8 setae on each basal article and 5 on apical, penis with only 2+2 setae (Fig. 78).

Paratypes (female): Characters concurring in general with those of male, differences occur in terminal body segments: Paratype A: length 10 mm, 0.5 mm in width, with 33 pairs of legs. Ultimate pedal segment: structure and pilosity as shown in Figure 82. Right coxopleuron with 14 pores, left with 17. Tarsal claw (pretarsus) relatively larger than in male. Structure and pilosity of postpedal segments as in Fig. 82. Basal article of gonopods with 5 setae on right gonopod and 3 on left; apical article with a single seta on both gonopods. Paratype B: length 10 mm, width 0.5 mm, 35 pairs of legs. Right coxopleuron of ultimate leg with 11 pores, left with 13; basal segment of both gonopods with three setae; apical segment of right gonopod with two setae, that of left gonopod with one.

Remarks: Specimens from Whitetop Mountain were collected in litter and rich black soil under *Picea rubens* and *Betula alleghaniensis* at an elevation of about 5000 ft ASL. Those from "The Priest" (165 miles further northeast) were taken from a pitfall trap in a mixed hardwood stand at 3900 ft. The collections in May and July indicate that the species may be active in the upper soil horizons throughout the year in cool and

damp biotopes.

The two female examples (paratypes A and B) contain spermatozoa in their spermathecae (Fig. 83), indicating sexual maturity. Nonetheless, on the basis of various non-sex related characters such as body size, number of coxal pores, and pilosity of various body parts, we consider them to be not fully mature but in the "maturus junior" stage. The two males from "The Priest" likewise appear to be in the same stage of maturity, with mature spermatozoa visible after clearing.

The form of the labrum in Figure 55 is slightly altered by pressure of the cover slip of the preparation. In Figure 77, the structure of the last pedal segment and postpedal segments was probably altered by the osmotic effect of the preservative. Figure 82 does not represent the typical structure and pilosity of a fully adult specimen (in a "maturus senior" female the number of coxal pores would be greater, and the setae larger).

In the absence of substantiating synapomorphies, we regard the low number of body segments in this species and *E. paucipes* to represent homoplastic convergence in a reductive trend, rather than a trait derived from common ancestry.

Distribution: So far this species is known from three localities in the Blue Ridge Physiographic Province in Virginia (Map 3). There can be little doubt that it also occurs to the south in North Carolina and Tennessee, at elevations above 4000 ft.

Escaryus liber Cook & Collins
(Figures 84-92, Map 2)

Escaryus liber Cook & Collins, 1891, Proc. U. S. Nat. Mus. 13: 394.

Holotype female (present location unknown) from Kirkville, Onondaga County, New York, April 1890, Cook & Collins leg.—Attems, 1903, Zool. Jahrb. Syst. 18: 196.—Cook, 1904, Harriman Alaska Exped. 8: 77.—Chamberlin, 1923, Pan-Pac. Ent., 23(1): 37.—Attems, 1927, Zool. Anz. 72: 303.—Bailey, 1928, Bull. New York State Mus., 276: 19,43.—Attems, 1929, Das Tierreich 52: 98.—Crabill, 1953, Journ. New York Ent. Soc. 61: 97.—Crabill, 1961, Ent. News 72: 70.

Material: One female from Rochester, New York, 8 December 1956 (collector not specified), Crabill det. (USNM).

Diagnosis: Among the species with complete paraclypeal suture, *E.*

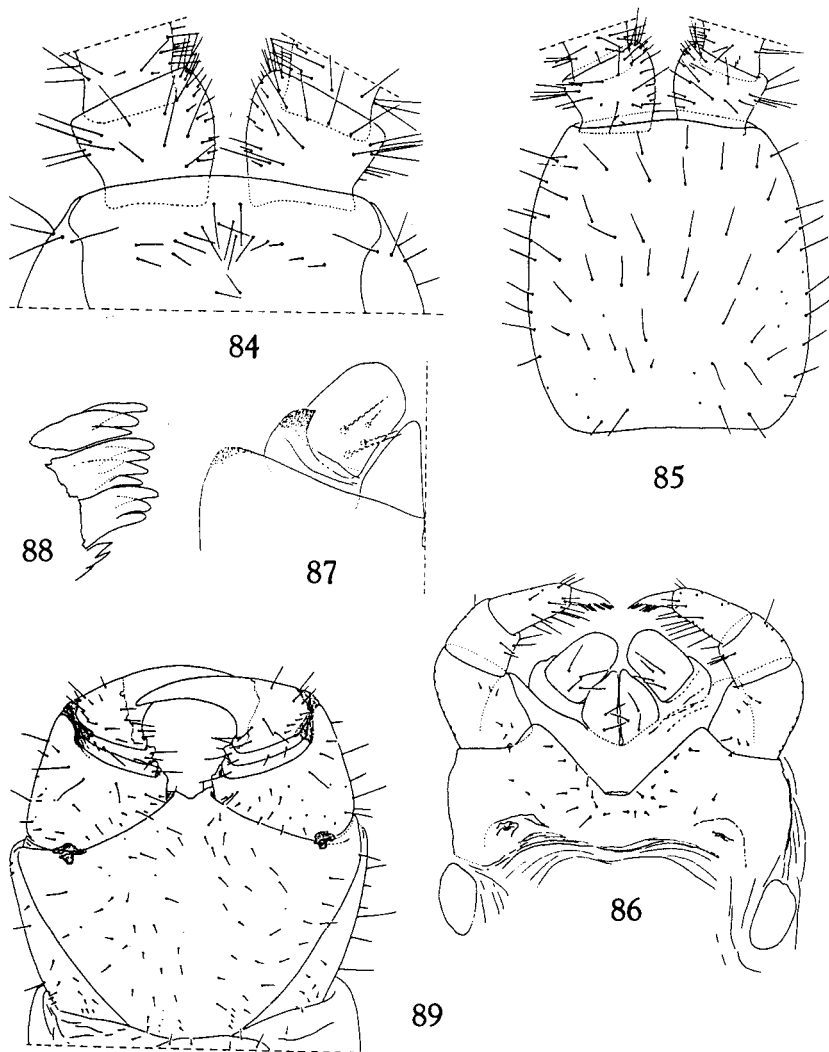

Figures 84-89. *Escaryus liber* (female from Rochester, New York). 84. Clypeus and basal antennomeres. 85. Cephalic sclerite. 86. 1st and 2nd maxillae. 87. Right side of first maxillae, dorsal view. 88. Mandibular dentate lamellae. 89. Prehensorial segment, ventral view.

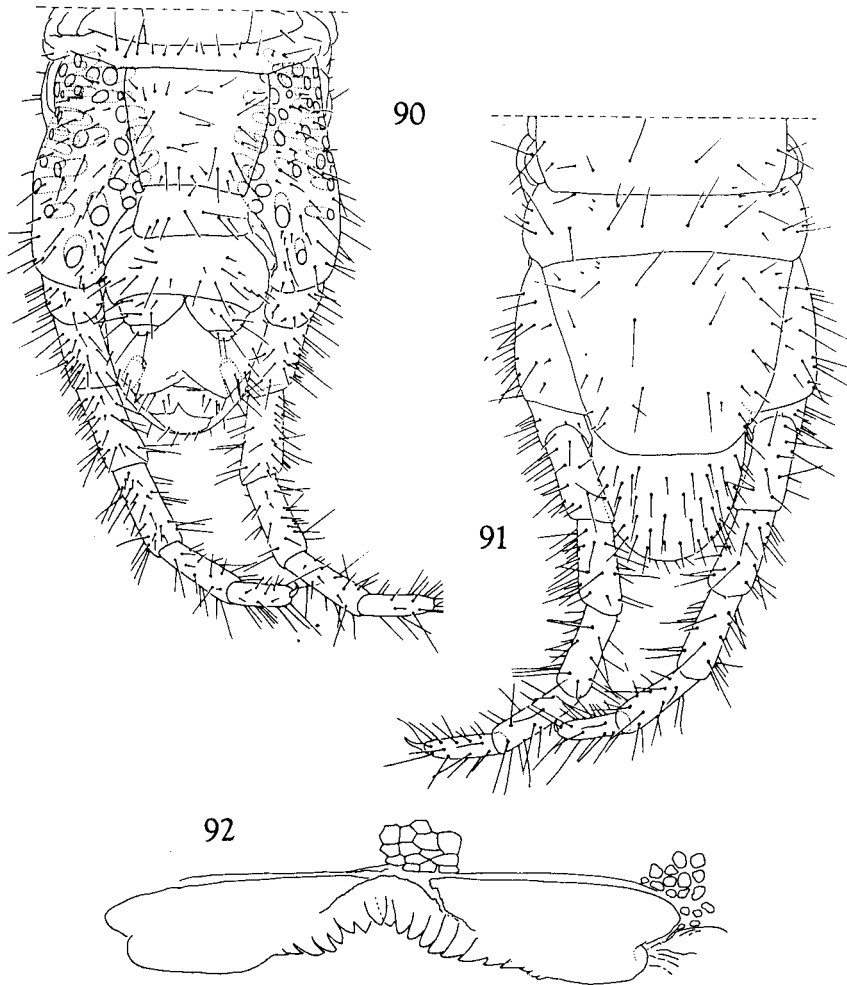

Figures 90-92. *Escaryus liber* (female from Rochester, New York). 90. Last pedal segment and postpedal segments, ventral view. 91. The same, dorsal view. 92. Labrum.

liber is distinguished by its high number of pedal segments (47-49).

Description: (female cited above): Length, 32 mm, maximum width, 1.0 mm, body with 49 pedal segments.

Antennae approximately 3.3 times longer than cephalic sclerite; pilosity of antennomeres similar on dorsal and ventral surfaces. Ultimate article with about 23 claviform setae on external border, about 18 on internal, apex with a group of about 5 very small undivided setae. Articles 2, 5, 9, and 13 with specialized setae similar to those of 14 distributed as follows (dorsal/ventral): 2nd, 1-2/1; 5th, 2-5/1; 9th, 6/2-3; 13th, 1-3/3.

Cephalic sclerite slightly (10%) longer than broad, its shape and setation shown in Figure 85. Entire surface of clypeus uniformly reticulate, with 1+1 postantennal, 7+7 transverse median, and 1+1 prelabral setae; paraclypeal suture complete (Fig. 84). Labrum with a total of 17 dentations, 13 well-developed on median arch and 2 smaller acute on each lateral labromere (Fig. 92).

Dentate lamella of mandible composed of three blocks with formula 3-4-3 (Fig. 88), innermost block subtended by a group of about three small hyaline fimbriae; pectinate lamella with about 13 hyaline denticles. Coxosternum of maxillae I without setae and with rudimentary palps (Fig. 87), median prolongation subtriangular, well developed and provided with 2+3 large setae. Palps of basal telopodite article small, not attaining midlength of distal (Fig. 87), latter with 4+4 setae on ventral side (Fig. 86) and 4+4 sensory papillae on dorsal. Coxosternum of maxillae II with 14+13 setae. Apical claw of telopodite well-developed and bipectinate with about 11 pectines on each edge. Shape and setation of maxillae II shown in Figure 86.

Closed telopodites of prehensors not attaining anterior edge of cephalic sclerite. Interno-apical surface of trochanteroprefemur and femur with very poorly developed tooth or tubercle, tibia with distinct tooth, tarsungulum without basal tooth, in its place is a small obtuse elevation, unsclerotized and similar in color to adjacent surfaces. Toxicodene with cylindrical calyx. Structure and setation of prehensorial segment shown in Figure 89.

Setation of legs uniform throughout length of body. Tarsal claws smooth, each with two ventrobasal parungues of similar size and a smaller third close to base of the posterior primary.

Sterna of 3th to 13th segments with shallow median longitudinal depression; 7th to 12th with median transverse semicircular sacculus on anterior border.

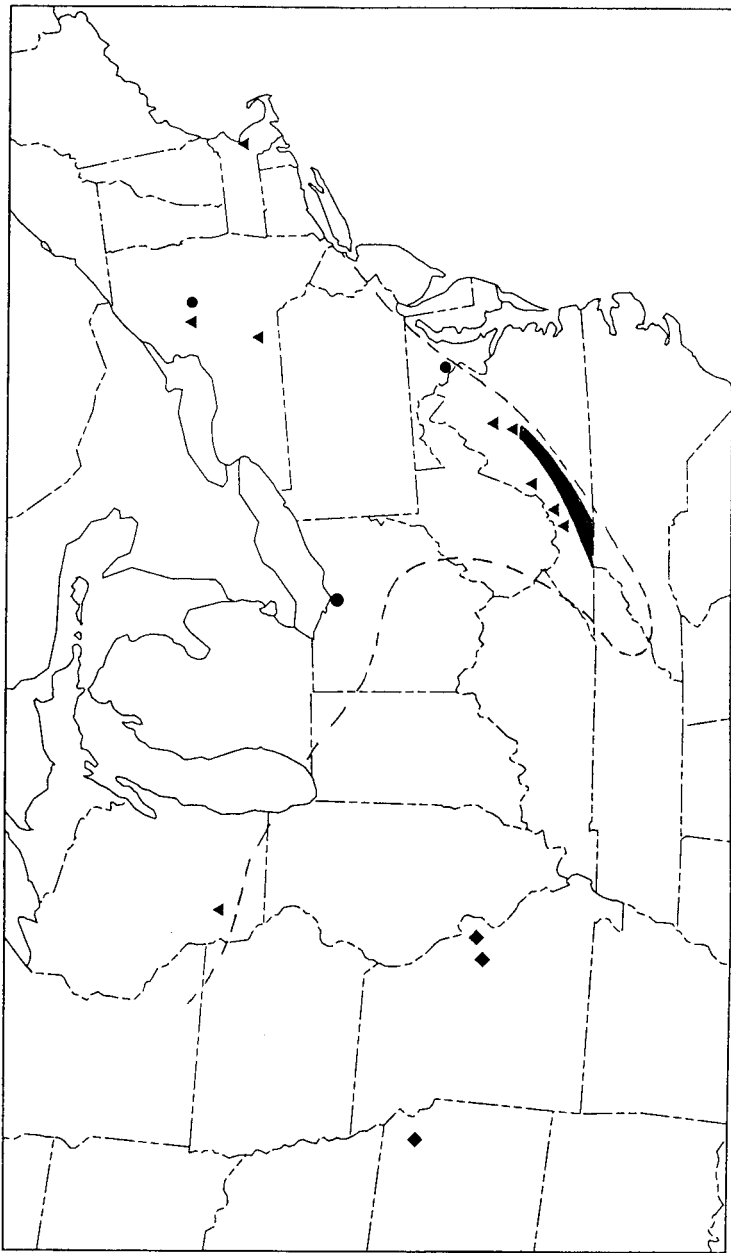

Map 2. Distribution of three species of *Escaryus* in northeastern United States. Triangles, *E. urbicus*; dots, *E. tiber*; diamonds, *E. missouriensis*. Symbols include literature records considered to be reliable. The black area in Virginia contains the ranges of *E. orestes* and *E. cryptorobius*, shown in detail in Map 3.

Pretergum of last pedal segment without visible suture between its pleurites, presternum not medially divided. Tergum trapezoidal, basal width greater than length, shape and setation as shown in Figure 91). Sternum trapezoidal, lateral edges convergent posteriad, shape and setation as shown in Figure 90. Coxopleura with about 30 pores of irregular sizes dispersed over lateral and ventral surfaces; shape, setation, and pore location represented in Figures 90 and 91. Podomeres of terminal legs (Figs. 90, 91) slender, setae slightly smaller and more numerous on ventral side.

Posterior edge of sternum of intermediate postpedal segment straight to slightly concave, posterior edge of tergum convex. Genital segment I with posterior edge slightly concave; basal article of gonopods with 5+8 setae, distal with 2+3 (Figs. 90, 91).

Male: A description of the male has not appeared in the literature, and the only reference appears to be that of Crabill (1953: 97): "Pairs of legs: 47 or 49 (usually 47) in the male."

Variation: Crabill (1953: 97) ascribed 47-49 segments to the female sex of this species, the latter number the more common. He recorded 18-25 coxopleural pores (30 in our specimen), and 10-13 labral teeth (17 in ours).

Distribution: New York, Maryland, District of Columbia, Ohio. Until 1953, the only locality recorded for this species was Kirkville, New York (Cook & Collins, 1891: 395). In his synopsis of schendylids of northeastern United States, Crabill (1953: 97) stated that "The species is known only from the following northeastern localities: NEW YORK: Ithaca, Taughannock Falls State Park; Varma; Kirkville. MARYLAND: Lanham. DISTRICT OF COLUMBIA: Washington. OHIO: Cleveland." Presumably material from these additional localities was represented in Dr. Crabill's personal collection; we were unable to locate these specimens for verification.

Remarks: Neither the original description nor the "specific diagnosis" published by Crabill provide sufficient detail about many characters of diagnostic importance; the deficiency is herewith corrected with our description and figures.

We were unable to find either the original type specimen or material upon which Crabill based his 1953 account. Nonetheless we believe that the specimen described here as *liber* is correctly identified since it agrees sufficiently with the original description and originated from a place (Rochester, New York) only 100 km from the type locality.

Escaryus paucipes Chamberlin
(Figures 93-101, Map 1)

Escaryus paucipes Chamberlin, 1946, Ann. Ent. Soc. America 39 (2):179. Male holotype (USNM) from Haines, Alaska (59.14N, 135.27W), 23 August 1945 (legit?).— Chamberlin, 1947, Pan-Pac. Entom. 23(1): 37-39.— Chamberlin, 1949, Ent. News 60(1): 14.— Chamberlin, 1961, Ent. News 72(3): 70.— Kevan, 1983, Canadian Journ. Zool. 61: 2945.

Material: Male holotype (USNM) from Haines, Alaska (but see "Remarks" below).

Diagnosis: *Escaryus paucipes* differs from other members of the genus, except *E. cryptorobius*, in the very reduced number of legs (33), and from that species in a number of characters cited in couplet 4 of the foregoing key.

Description: Adult male, 14 mm in length, 0.5 mm in maximum width, with 33 pairs of legs.

Antennae approximately 2.3 times longer than cephalic sclerite. Setae of antennomeres somewhat larger and more numerous on ventral side. Ultimate article with about 18 claviform setae on the outer side, four on the inner; extreme apex with a group of about six specialized very small setae, clear in color and with tips apparently not divided. Articles 2, 5, 9, and 13 each with one dorsal and one ventral seta similar to the preceding, the dorsal setae clear on articles 2 and 5, ochraceous on 9 and 13.

Cephalic sclerite distinctly (20%) longer than broad, its shape and setation shown in Figure 96. Surface of clypeus uniformly reticulate, with 1+1 postantennal, 3+3 medial transverse, and 1+1 prelabral setae. Paraclypeal suture complete (Fig. 95). Labrum with a total of 23 dentations, 11 of which on the median labromere and 6 on each lateral labromere, where becoming extremely small with very fine apex (Fig. 98).

Dentate lamella of mandible apparently divided into three blocks with formula 3-4-3, innermost block subtended on mesal side with a cluster of 4-5 small, sclerotized denticles (Fig. 97); pectinate lamella with 12 hyaline teeth. Coxosternum of maxillae I without setae, palps very small, median prolongation well-developed, subtriangular, with 2+1 setae. Basal article of telopodite with small palps, not attaining midlength of distal article, latter with 1+1 setae on ventral side (Fig. 99). Coxosternum of maxillae

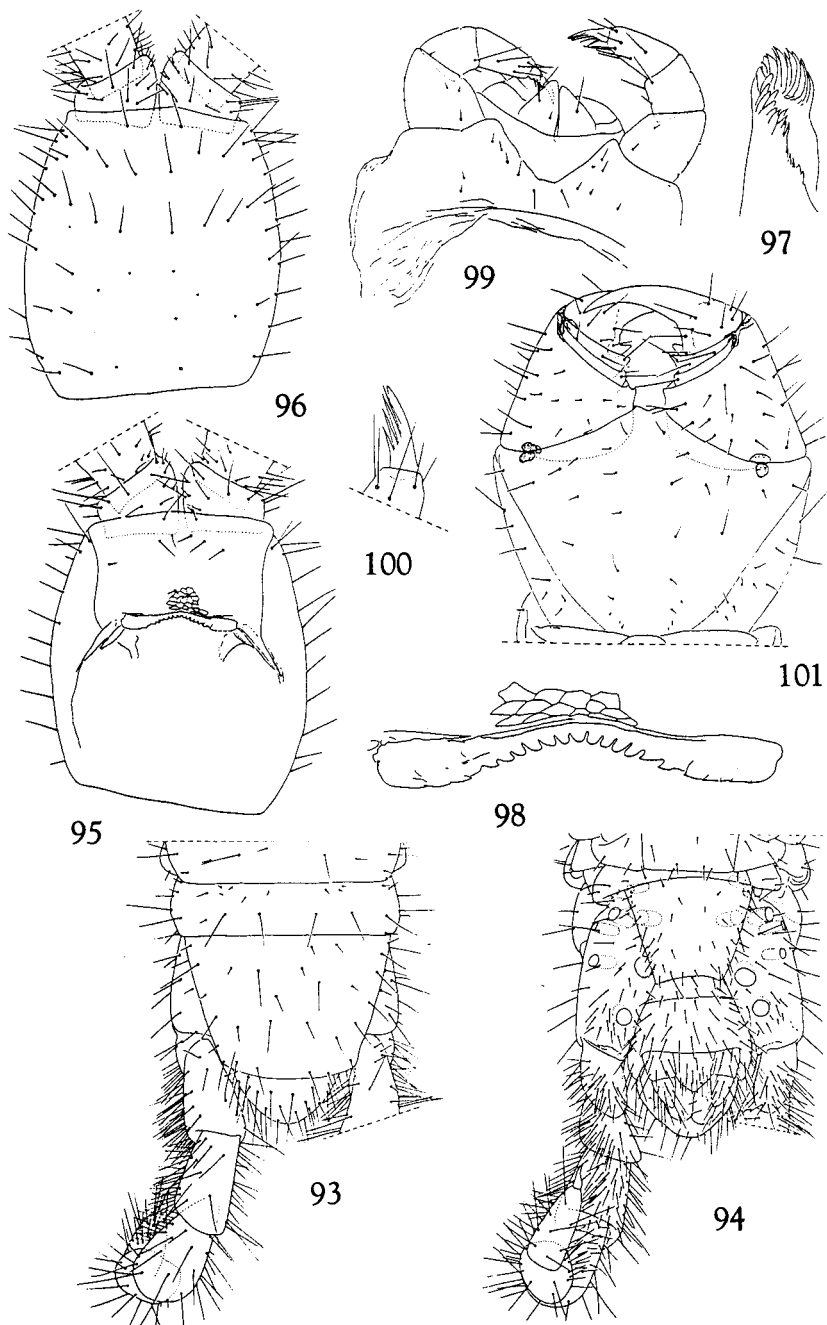

II with 7+7 setae as represented in Figure 99. Apical claw well-developed, with five pectines on each ventral edge (Fig. 100). Shape and setation of telopodites (Fig. 99).

Closed telopodites of prehensors not attaining anterior border of cephalic sclerite. Internal apical surface of trochanteroprefemur, tibia, and tarsungula with well-developed tooth, femur edentate. Calyx of toxicodene small and cylindrical. Prehensorial structure depicted on Figure 101.

Pedal chaetotaxy similar on all legs except the last pair; surface of claws smooth. Each claw with the usual two large and one much smaller parungues.

Anterior sterna with very shallow median depression concolorous with rest of surface, and lacking anterior median sacculus.

Pretergum of last pedal segment without visible suture between pleurites, presternum not medially divided. Tergum trapezoidal with basal width much greater than length (Fig. 93). Sternum trapezoidal with basal width greater than length, setation composed of moderately large scattered setae, shape and chaetotaxy as shown in Figure 94. Coxopleura with 8+8 pores of distinct size distributed over ventral surface as represented in Figure 94. Ultimate legs with broad podomeres with numerous small ventral setae. Setae of dorsal surface much less numerous and smaller in size. Shape, chaetotaxy, and general appearance of these legs shown in Figures 93 and 94.

Posterior edge of sternum of intermediate postpedal segment slightly concave, that of tergum convex. Posterior edge of genital segment I somewhat convex. Basal article of gonopods with 8+11 setae, distal with 9+11. Structural details of this segment shown in Figures 93 and 94.

Female: Unknown.

Distribution: Aside from the type locality this species is known only from a collection site identified by Chamberlin (1949: 15) only by the coordinates 68.20N and 151.30W. This locality is on the north side of Anaktuvuk Pass in the Brooks Range, and if the data and identification are both correct, would suggest a range over much of eastern Alaska and southwestern Yukon Territory as the two localities are 750 miles apart.

←

Figures 93-101. *Escaryus paucipes* (male holotype). 93. Last pedal segment and postpedal segments, dorsal view. 94. The same segments, ventral view. 95. Cephalic sclerite, ventral view. 96. The same, dorsal view. 97. Dentate and pectinate lamellae of mandible. 98. Labrum. 99. 1st and 2nd maxillae. 100. Apex of left telopodite of 2nd maxillae, ventral view. 101. Prehensorial segment, ventral view.

Remarks: Chamberlin's original description, based solely on the holotype male, included only two uninformative sketches and did not provide information on many characters of importance. These deficiencies are herewith ameliorated by the present account based on the same specimen. During our study of the type we noted some discrepancies with the original description. The statement "No anal pores detected" conflicts with the reality shown in Figure 131; "First maxillae without membranous lappets" does not correspond with our observation of these structures; and the dental formula 3-4-5 must be corrected to 3-4-3.

Chamberlin (1949: 15) mentioned a second example of this species (which we have been unable to locate) with the remark "The female here recorded agrees with the male in having...". But in a subsequent sentence (under "Locality") he wrote "One male taken August 30, 1948, by Neal A. Weber". Unless the specimen itself can be found there seems to be no way to verify its actual sex.

Finally, although the published description stipulates "Haines, Alaska" as the type locality, the holotype preparation is labeled, in Chamberlin's handwriting, "Alaska: Juneau", adding another element of mystery to the case of *paucipes*.

Ethopus-Group

Escaryus ethopus (Chamberlin)

(Figures 102-116, Map 1)

Geophilus ethopus Chamberlin, 1920, Proc. Biol. Soc. Washington 33:43. Holotype male (MCZ TC-39) from Iditarod, Alaska.—Attems, 1929, Das Tierreich, 52: 328.

Escaryus ethopus: Crabill, 1961, Ent. News, 72(3): 69.—Kevan, 1983, Can. J. Zool. 61: 2945.

Escaryus delus Chamberlin, 1946, Ann. Ent. Soc. America 39: 178. Holotype male (USNM) from Circle City, Alaska. **New Synonymy!** — Chamberlin, 1947, Pan-Pacific Ent. 23(1): 37.—Crabill, 1961, Ent. News 72(3): 69.—Kevan, 1983, Can. J. Zool. 61: 2945.

Escaryus japonicus [nec Attems, 1903]: Chamberlin, 1952, Ent. News, 63(8): 209 {misidentification}.

Material: ALASKA: Iditarod (?River, 63N, 158W), June 1918, A. H. Twitchell, holotype of *Geophilus ethopus* (MCZ), represented by com-

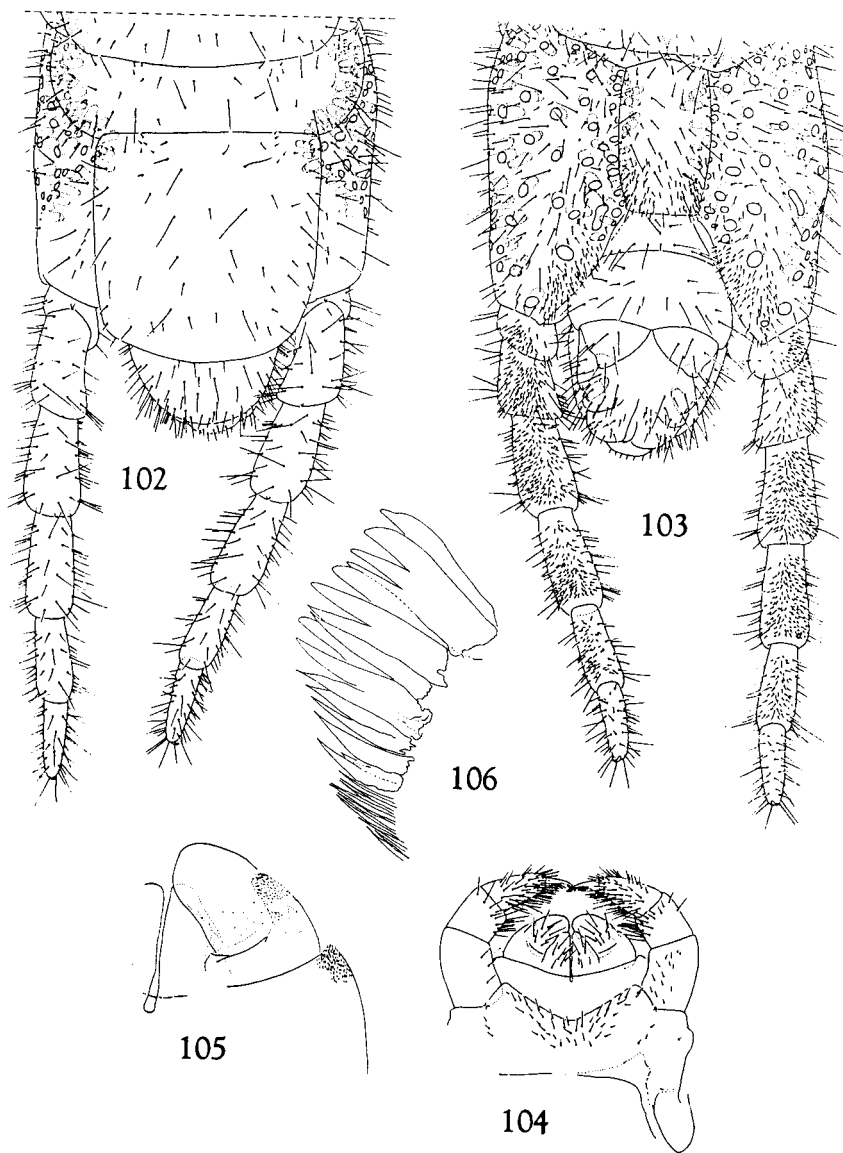

Figures 102-106. *Escaryus ethopus* (female from LaPierre House, Yukon). 102. Last pedal and postpedal segments, dorsal view. 103. The same segments, ventral view. 104. 1st and 2nd maxillae. 105. Right side of 1st maxillae, dorsal view. 106. Dentate lamella of mandible.

plete body in three fragments + head capsule with mandibles attached + 1st and 2nd maxillae, in alcohol. Circle City (65.44N, 144W): 21 June 1945, J. C. Chamberlin and Jeane Johnson, holotype of *Escaryus delus* (USNM), represented by the body (divided into three parts) in alcohol and by a microscopic preparation of the head capsule and mouth parts. Fairbanks, 22 September 1943, J. C. Chamberlin, female paratype of *Escaryus delus* (USNM), entire specimen in alcohol, head and mouthparts dissected; "near Fairbanks", 1 September 1947, C. E. Prince, 1 male, 1 female, 1 immature (identified as *Escaryus delus* by R. V. Chamberlin) (USNM). Mount McKinley National Park, 17 August 1958, C. H. Lindroth, 1 male, 2 females (USNM); "McKinley Park", 27 February 1948, 1 male, J. S. Stanford (identified as *Escaryus japonicus* Attems by R. V. Chamberlin) (USNM). Nulato (64.45N, 158.06W), 16 May 1867, W. H. Dall, 2 males, 3 females (USNM).

CANADA: Yukon Territory: 4 mi. west of Lapierre House, 2000 ft., 5 August 1964, I. Sterling, 1 female (described below) (CNC). Swede Dome, 34 miles west of Dawson, 3800 ft., 5 June 1962, R. E. Leech, 6 males, 6 females (CNC); same locality, but 3900 ft., 2 June 1962, 1 male (CNC); same locality, but without elevation, 5 June 1962, P. J. Skitsko, 2 males, 2 females (CNC).

Diagnosis; *Escaryus ethopus* shares with *E. missouriensis* the characters of incomplete paraclypeal suture and reticulate surface of the lateral labromeres, the two taxa differ as specified in the second key couplet above.

Description (female from 4 mi. west of Lapierre House, Yukon). Body 50 mm in length, 2 mm in width, with 45 pairs of legs.

Antennae approximately 3.2 times as long as cephalic sclerite, setae progressively smaller and more numerous toward the distal end. pilosity of the articles similar on dorsal and ventral sides. Ultimate article with about 60 claviform setae on external apical surface and about 38 on internal, apex with a group of about 20 very small and simple specialized setae. Articles 2, 5, 9, and 13 dorsally and ventrally with a group of very small setae similar to those on apex of 14, numerically dispersed as follows (dorsal/ventral): 2nd: 7-8/6-7; 5th: 11-13/11-12; 9th: 15-18/8-11; and 13th: 14/7. Cephalic sclerite about 10% longer than wide (Fig. 114). Clypeus with two non-reticulated prelabral areas (plagulae) (Fig. 107), chaetotaxy represented by 1+1 postantennal, 4+4 anterolateral, 9+8 irregularly transverse, and 1+1 prelabral setae; paraclypeal suture incomplete (Fig. 109). Median labromere with 15 darkly colored denti-

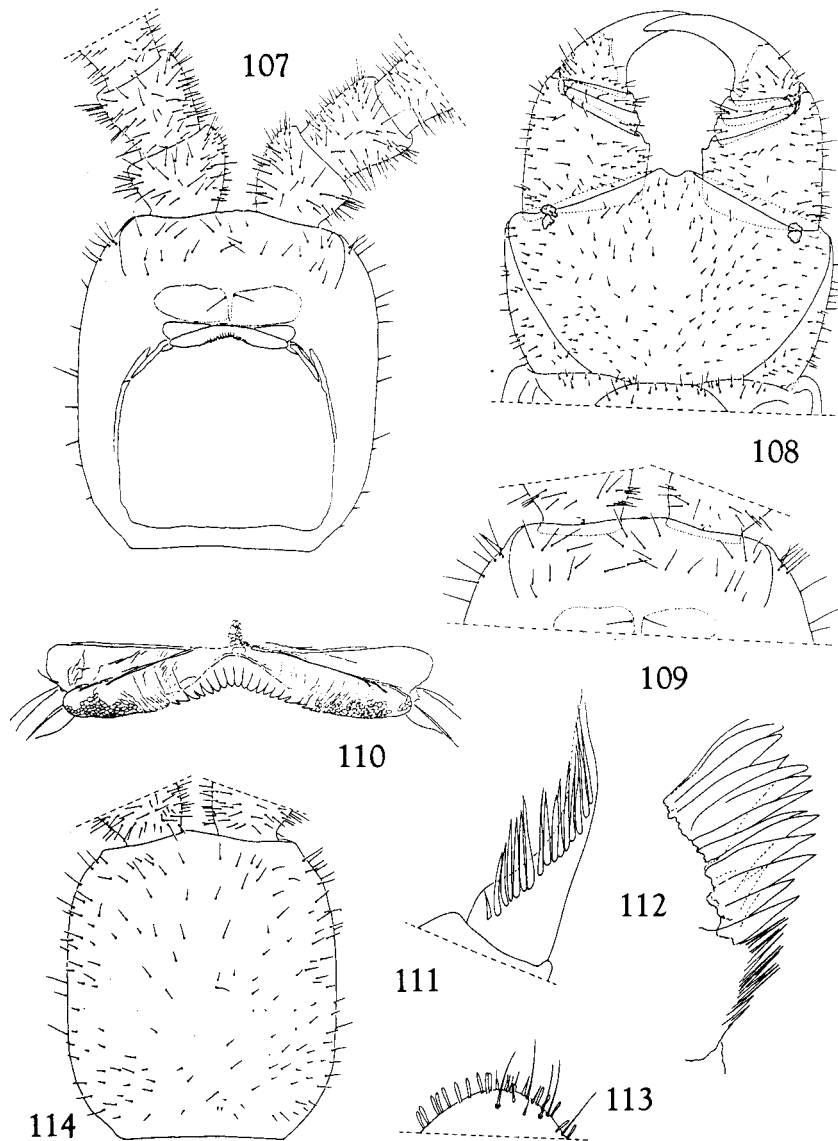

Figures 107-114. *Escaryus ethopus* (female from LaPierre House, Yukon). 107. Cephalic sclerite, ventral view. 108. Prehensorial segment, ventral view. 109. Clypeus and basal antennomeres, ventral view. 110. Labrum. 111. Apex of left telopodite of 2nd maxillae, ventral view. 112. Dentate lamellae of mandible. 113. Apex of left 14th antennomere, showing specialized and claviform setae. 114. Cephalic sclerite, dorsal view.

form lobes; surface of lateral labromeres reticulated adjacent to the mesal margin, edge provided with 4+5 very small dentations adjacent to median arch (Fig. 110).

Dentate lamella of mandible divided into three blocks with formula (on the two mandibles) 4-4-7 and 4-4-6 (Fig. 106); innermost block subtended on mesal side by a group of 7-12 hyaline fimbriae; pectinate lamella with about 45 hyaline teeth (Fig. 106). Coxosternum of 1st maxillae lacking setae; provided with very small but well-defined palps (Fig. 105); median prolongation subtriangular, well developed and provided with 7+7 large setae. Telopodite biarticulate, first article with well developed palps extending to middle of second article, which bears 8+8 setae on ventral side (Fig. 104) and 12+13 sensory papillae on the dorsal (Fig. 105). Coxo-

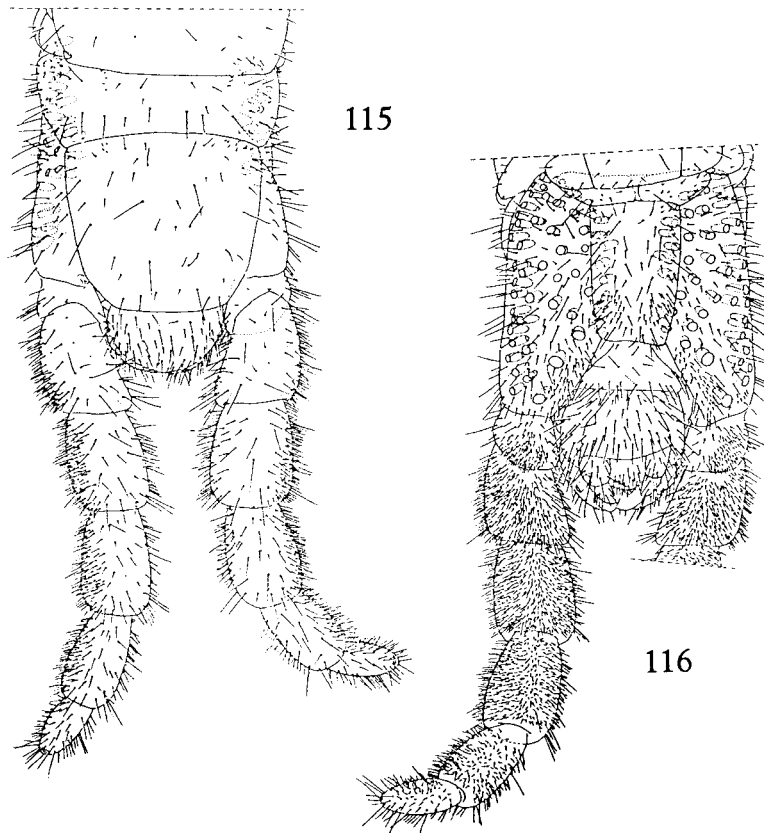

Figures 115-116. *Escaryus ethopus* (male). 115. Last pedal segment and postpedal segments, dorsal view. 116. The same segments, ventral view.

sternum of 2nd maxillae with 27+24 setae dispersed as shown in Figure 104. Apical claw of telopodite well developed and bipectinate, each comb with about 16 hyaline pectines (Fig. 111). Shape and chaetotaxy of telopodite articles as in Figure 104.

Telopodites of prehensors not exceeding anterior border of cephalic capsule when normally flexed. Internal apical border of trochanteroprefemur bearing a conspicuous tooth; femur and tibia with very small obscure tubercle in this position; base of tarsungulum with neither tooth nor tubercle. Calyx of toxicodene cylindrical. Form and setation of telopodite, coxosternum, and pleurites as shown in Fig. 108.

Chaetotaxy of legs similar on all except last pair. Surface of tarsal claws smooth, not squamous. Each claw provided ventro-basally with two primary parungues, anterior and posterior, of similar size and dark in color, as well as a much smaller, light-colored third placed internally near base of posterior primary.

Sterna without sacculi; 2th-15th with shallow median longitudinal depression concolourous with rest of surface.

Pretergum of last pedal segment without visible suture between its pleurites, presternum medially divided. Tergum trapezoidal, slightly longer than basal width (shape and pilosity as in Fig. 102). Sternum distinctly longer than wide, shape and pilosity as shown in Fig. 103). Coxopleura with about 65 pores of variable size dispersed over nearly all the surface (only dorsomedial posterior area poreless), as indicated on Figs. 102 and 103). Articles of terminal legs slender, their chaetotaxy represented ventrally by a few large setae and numerous small setae, pilosity sparser dorsally, with only large setae present. Shape, setation, and relative size of podomeres, and size of tarsal claw relative to metatarsus as shown in Figs. 102 and 103.

Sternum of intermediate postpedal segment with concave posterior edge, tergum posteriorly convex; posterior edge of 1st genital segment slightly convex medially, concave on both sides; 5-6 setae on basal article of gonopods and two on apical (Figs. 102-103).

Male: Characters of male sex concur closely with those of female, differences manifested primarily in posteriormost segments, as illustrated by Figures 115 and 116: pretergum of ultimate pedal segment without visible suture between its pleurites, presternum medially divided. Tergum trapezoidal, length equal to basal width. Sternum notably (60%) longer than wide, lateral borders slightly convergent posteriad; shape, pilosity, and pore distribution of coxopleura as drawn. Podomeres of terminal legs

broad, invested by numerous small setae on ventral side; setae of dorsal side larger and much less numerous.

Both sternum and tergum of intermediate postpedal segment with convex posterior edge; that of 1st genital segment convex; basal article of gonopods with about 15 setae, apical with about 12.

Variation: Maximum length observed in females, 65 mm, in males 41 mm. Only four females of the 16 measured, however, exceeded 40 mm in length. The number of pedal segments varied in both sexes between 41 and 47, with 43 the modal number for males and 45 for females:

| Segments | Number of | |
|----------|------------|--------------|
| | Males (15) | Females (16) |
| 41 | 3 | 2 |
| 43 | 6 | 3 |
| 45 | 4 | 10 |
| 47 | 2 | 1 |

Distribution: Central Alaska, Yukon Territory of Canada (Map 3).

Remarks: The original description of *Escaryus japonicus* by Attems and a more recent account by Shinohara (1970) suggest a close similarity between this species and *E. ethopus*. Indeed, the most conspicuous difference seems to be number of pedal segments and even these overlap (41-47 segments in *ethopus*, 47-55 in *japonicus*. As noted above, R. V. Chamberlin misidentified a specimen from "McKinley Park" as *japonicus* which emphasizes the similarity. We have not examined Japanese material in connection with this study, but no name change would be involved for the Alaskan species if the two names were found to be synonyms since *ethopus* has priority. Eventually, to be sure, this situation must be investigated conclusively.

Escaryus missouriensis Chamberlin
(Figures 117-154, Map 2)

1942. *Escaryus missouriensis* Chamberlin, Ent. News 53: 185.
Holotype male (present location unknown to us) from 4.3 miles northeast of Glencoe, St. Louis Co., Missouri.—Crabill, 1953, Journ. New York Ent. Soc., 61: 96.—Crabill, 1955, Ent. News 66: 38.—Crabill, 1961 Ent. News 72: 70.

Material: One male, 66 mm long with 55 pairs of legs, from 1 mile south of St. Albans, Franklin Co., Missouri, 3 January 1943, Leslie Hubricht (USNM); one female 44 mm long with 53 pairs of legs from Baldwin, Douglas Co., Kansas, J. C. Bridwell, 1900 (USNM). Both specimens had been identified as *missouriensis* by R. E. Crabill.

Diagnosis: This species shares with *E. ethopus* the characteristics of robust body, incomplete paraclypeal suture, and reticulate surface of lateral labromeres; it differs from *ethopus* as specified in key couplet 2.

Male (Franklin Co., Missouri): Body length 66 mm, maximum width 2.0 mm; 55 pairs of legs.

Antennae approximately 5.3 times longer than cephalic sclerite; pilosity similar on dorsal and ventral surfaces (shape and distribution of setae as in Figure 118). Terminal article with about 40 claviform setae on external border and about 30 on internal. Articles 2, 5, 9, and 13 with a group of very small specialized setae on both dorsal and ventral sides, numerically disposed as follows (dorsal/ventral): 2nd: 6-7/7-10; 5th: 8-12/9-12; 9th: 16-18/9-10; and 13th: 15-16/7-9 (Figures 130-138).

Cephalic sclerite 20% longer than broad, form and chaetotaxy as in Figure 117. Entire surface of clypeus uniformly reticulate, with 1+1 postantennal setae, 4+3 anterolateral setae; an irregular median cluster of 7+7 setae and 1+1 prelabral setae. Paraclypeal suture incomplete (**b**, Figure 126). Labrum with a total of 29 prominent acute teeth confined to the median labromere; lateral labromeres unusual in their reticulate surface along the outer margin. Form and structure of labrum and labral teeth shown in Figs. 141 and 142.

Dentate lamella of mandible divided into three blocks with formulae of 4-4-4 (left) and 3-4-4 (right); innermost block subtended on mesal side by a group of 15-20 small hyaline fimbriae (indicated with an arrow on Fig. 125); pectinate lamella with 26-30 hyaline teeth. Coxosternum of 1st maxillae lacking setae, and bearing slightly developed palps (Fig. 129); median projection subtriangular, well-developed and provided with 6+7 large setae. 1st article of telopodites with very well developed palp which surpasses midlength of 2nd article (Fig. 129); latter with 9+10 setae on ventral surface and 7+8 sensory papillae on the dorsal (Figs. 119 and 129). Coxosternum of 2nd maxillae with 28+24 setae dispersed as shown in Fig. 119. Apical claw of telopodite well developed and bipectinate, both dorsal and ventral edges composed of about 19 pectines (Fig. 121). Shape and chaetotaxy of telopodital articles as shown in Figures 119 and 128.

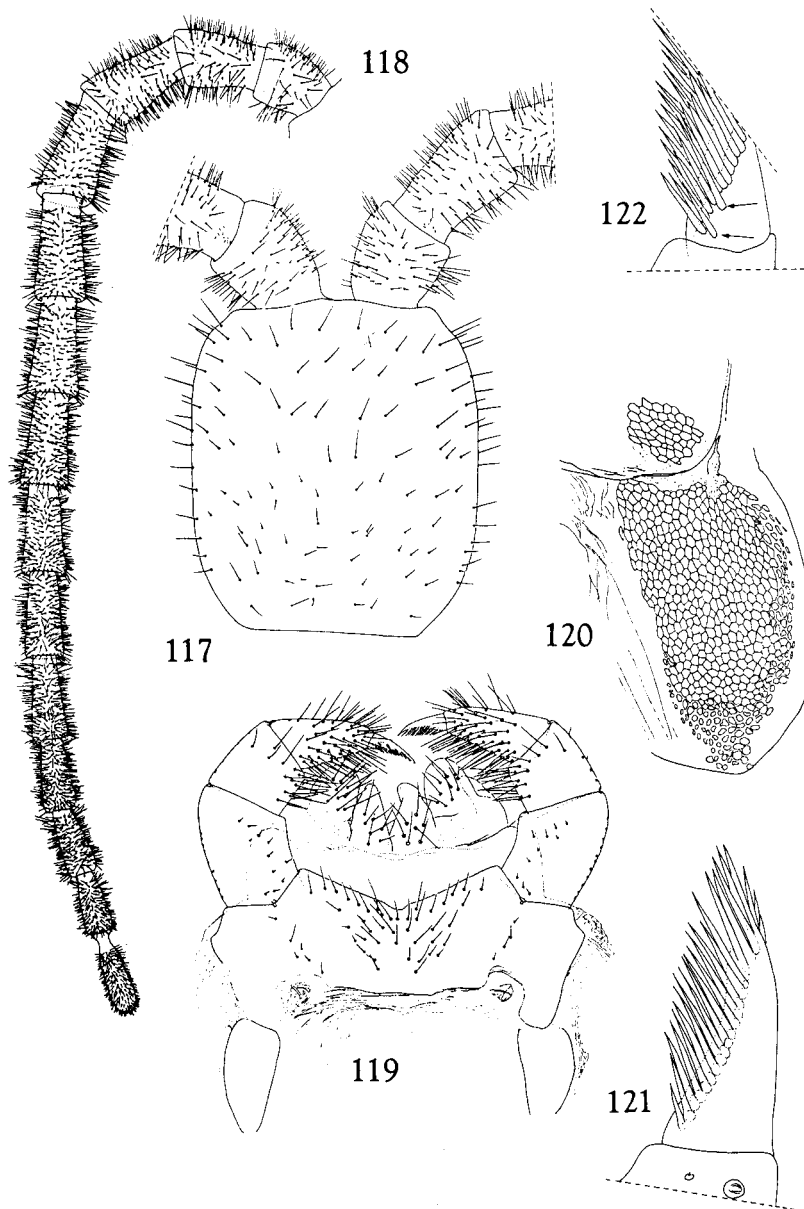

Prehensorial telopodites not surpassing anterior edge of cephalic sclerite when closed. Internal apical border of trochanteroprefemur bearing a well defined tooth; femur and tibia each with very small obscure tubercle; base of tarsungula with neither tooth nor tubercle. Toxicodene with cylindrical calyx (Fig. 124). Shape and chaetotaxy of prehensorial telopodites, coxosternum, and pleurites as shown in Fig. 143.

Setation of legs, except for last pair, similar throughout length of body. Surface of tarsal claws smooth, nonreticulate. Ventrobasal part of each claw provided with two principal parungues, one anterior and one posterior of similar size; internally and very close to posterior occurs a third much smaller parunguis (Fig. 140). A very small seta, of constant size, occurs in a ventro-posterior position on the tarsus of all legs.

Sterna without sacculus on anterior margin, 3d-14th with very shallow longitudinal depression concolorous with rest of sternal surface.

Pretergum of last pedal segment with visible suture between pleurites; presternum divided medially. Tergum trapezoidal, width of anterior base equal to median length (shape and setation as shown in Fig. 144). Sternum 60% longer than broad, its lateral edges gradually convergent toward posterior border (shape and setation as represented in Fig. 146). Coxopleura with about 100 small pores distributed over nearly entire surface (only dorsal posterior half and a small portion of ventral posterior internal areas devoid of pores); shape and chaetotaxy of coxopleura and disposition of pores shown in Figures 144-146. Podomeres of terminal legs not very broadened, with numerous setae which are more abundant on ventral side than on dorsal; shape, chaetotaxy, relative size of podomeres and of apical claw with respect to tarsus as shown in Figures 144, 146, 150, and 151. Posterior edge of sternum of intermediate postpedal segment concave, that of tergum convex; posterior edge of genital segment I slightly convex, pleura of this segment well developed; gonopods with about 17 setae on basal and apical articles (Fig. 149). Penis apparently without apical setae; form and setation of postpedal segments as in Figures 144, 146, 147, and 148.

Female: Two examples of this sex are known, the first is that cited by Crabill (1953: 97) from "Dallon's Spring Cave, Indiana." The very few

←

Figures 117-122. *Escaryus missouriensis* (male from Franklin Co., Missouri). 117. Cephalic sclerite and basal antennomeres, dorsal view. 118. Right antenna, ventral view. 119. 1st and 2nd maxillae, ventral view. 120. Left posterolateral sector of 2nd maxillae, ventral view. 121. Apical claw of left telopodite of 2nd maxillae, ventral view. 122. The same claw, dorsal view.

characters of this specimen mentioned by Crabill concur in general with those of the holotype and the male described above, except that the female has 57 pairs of legs and "some 16" labral teeth as opposed to the 29 present in the described male (Chamberlin did not mention the labrum of the holotype nor did Crabill describe labral dentition in the male from "Ranken"). The second female specimen is that cited here for the first time, collected at Baldwin, Kansas, having a length of 44 mm, width of 1.5 mm, and 53 pairs of legs. The differences shown by this female with respect to the described male are manifested in the structure of the antennae as well as last pedal and postpedal segments:

Antennae relatively shorter (approximately 3.2 times as long as the cephalic sclerite. Antennomeres notably thicker and with less abundant pilosity (Fig. 154).

Coxopleura with about 44 small pores distributed as shown in Figures 152 and 153. Podomeres of terminal legs slender, ventral surface of trochanter, prefemur, femur, and tibiae with small setae; relatively larger and less numerous setae occur on dorsal side (shape and setation of these structures shown in Figs. 152 and 153).

Posterior border of sternum of intermediate postpedal segment weakly convex, posterior border of tergum distinctly convex; genital segment I with posterior edge convex medially, concave on each side; gonopods with 8 setae on basal article and 3 on distal. Form and setation of postpedal segments as in Figures 152 and 153.

Variation: The maximum length known for *E. missouriensis* is 73 mm. The number of legs varies from 53 to 59, two males having the highest number, a female having the lowest.

Remarks: Inasmuch as neither the original description of the holotype by Chamberlin nor the subsequent record for a male and female by Crabill included illustrations, and since both accounts failed to mention a number of important anatomical features, the present detailed redescription corrects a long-standing deficiency in our knowledge of *missouriensis*. Even though we were unable to study the holotype, we concur with

→

Figures 123-129. *Escaryus missouriensis* (male from Franklin Co., Missouri). 123. 1st maxillae, dorsal view. 124. Distal part of right prehensor, ventral view. 125. Mandibular dentate lamellae and fringe of small hyaline fimbriae (arrow!). 126. Left latero-ventral sector of cephalic sclerite and basal antennomere (**a**, part shown enlarged in Fig. 127, **b**, paraclypeal suture). Fig. 127. Detail of section **a** of Fig. 126. Fig. 128. Right telopodite of 2nd maxillae, dorsal view. Fig. 129. Left side of 1st maxillae, dorsal view.

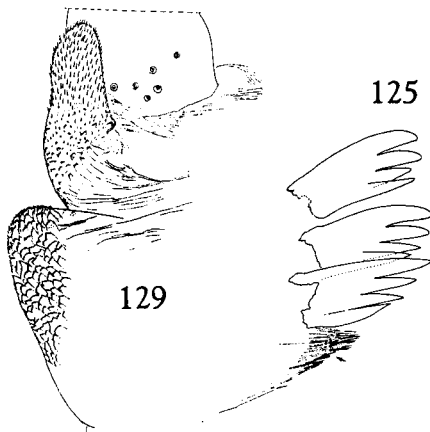
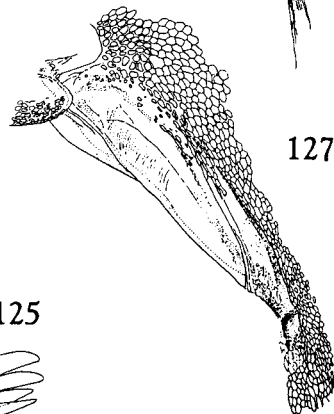
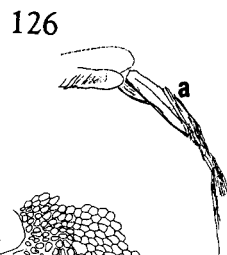
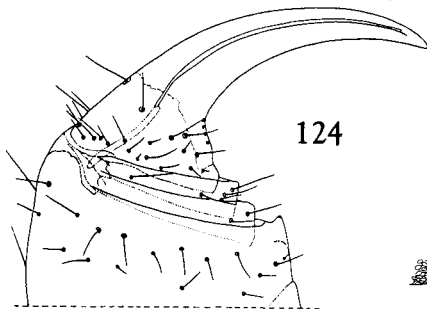
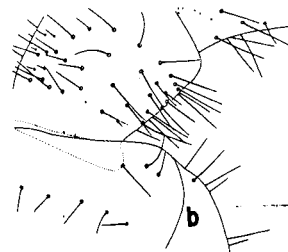
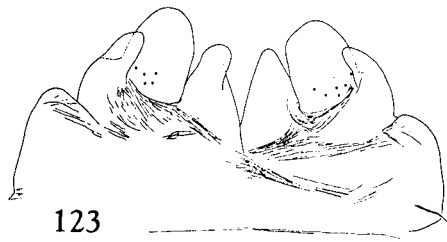

125



128

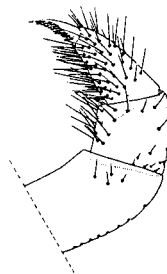

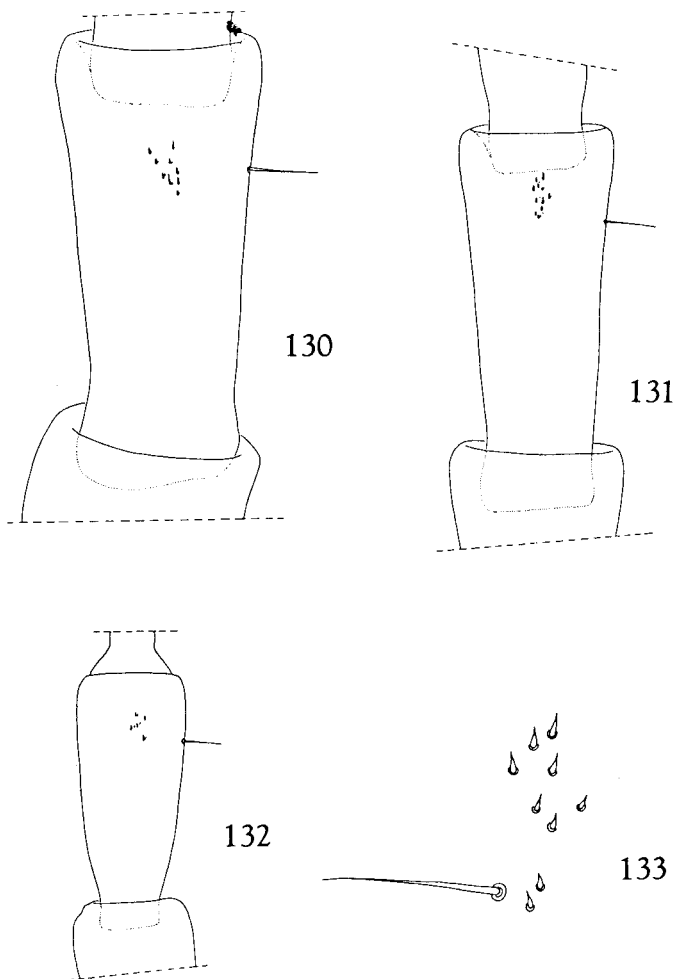

Figures 130-133. *Escaryus missouriensis* (male from Franklin Co., Missouri).
 130-132. Ventral surface of 5th, 9th, and 13th antennomeres showing location of specialized setae. Fig. 133. Detail of setae on ventral side of 9th right antennomere.

→
 Figures 134-142. *Escaryus missouriensis* (male from Franklin Co., Missouri).
 134. 2nd right antennomere, ventral view. 135-137. 5th, 9th, and 13th antennomeres, dorsal view. 138. Detail of specialized setae of 13th left antennomere, dorsal view. 139. Detail of palp of left telopodite of 1st maxillae, dorsal view. 140. Apical claw of 1st right leg, posteroventral view. 141. Labrum. 142. Detail of labral teeth in sector a of the preceding figure.

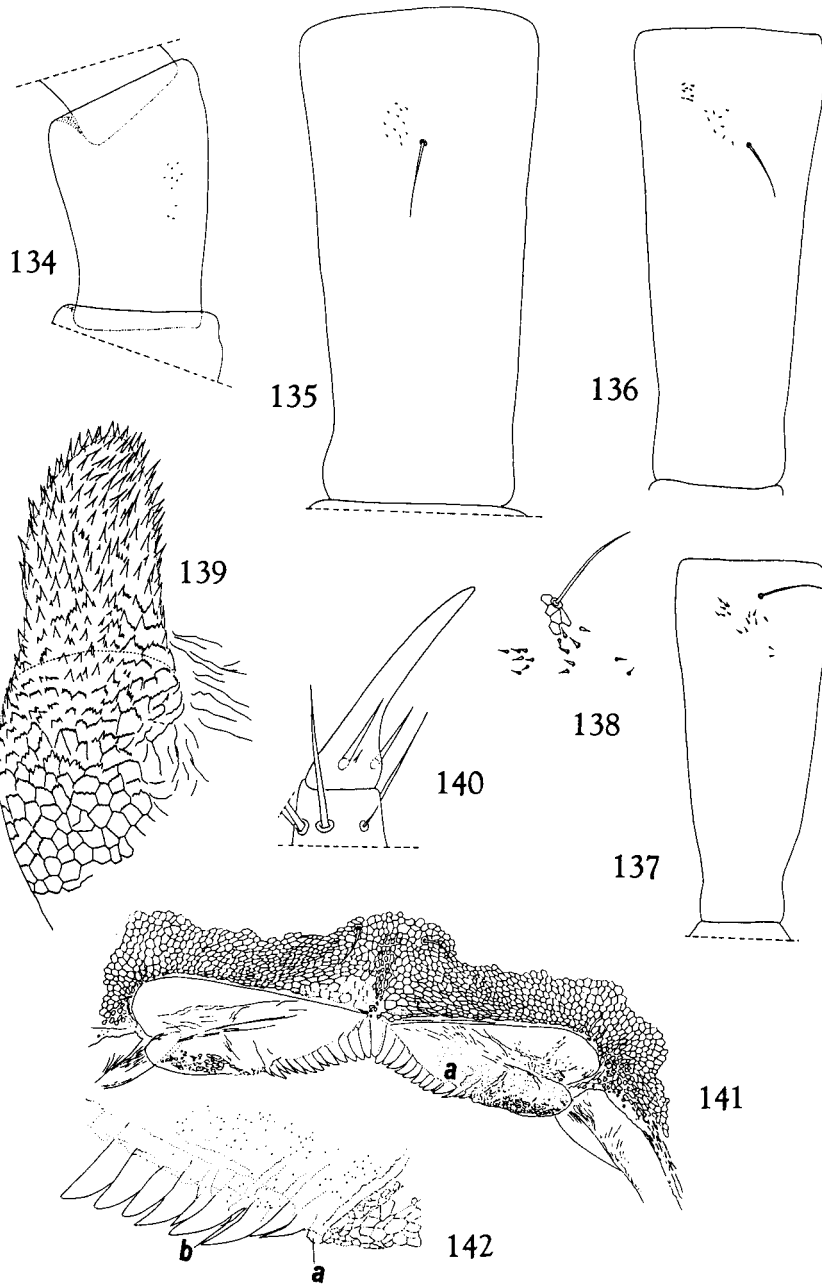

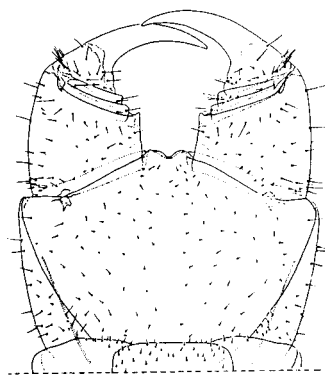
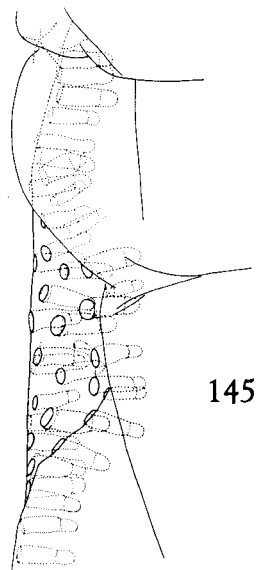
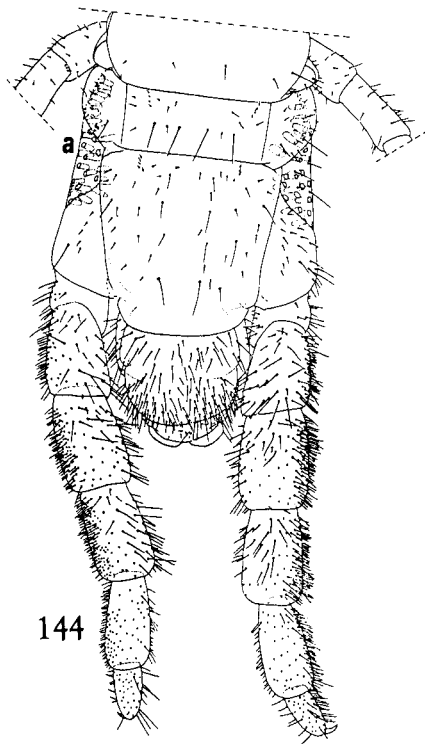

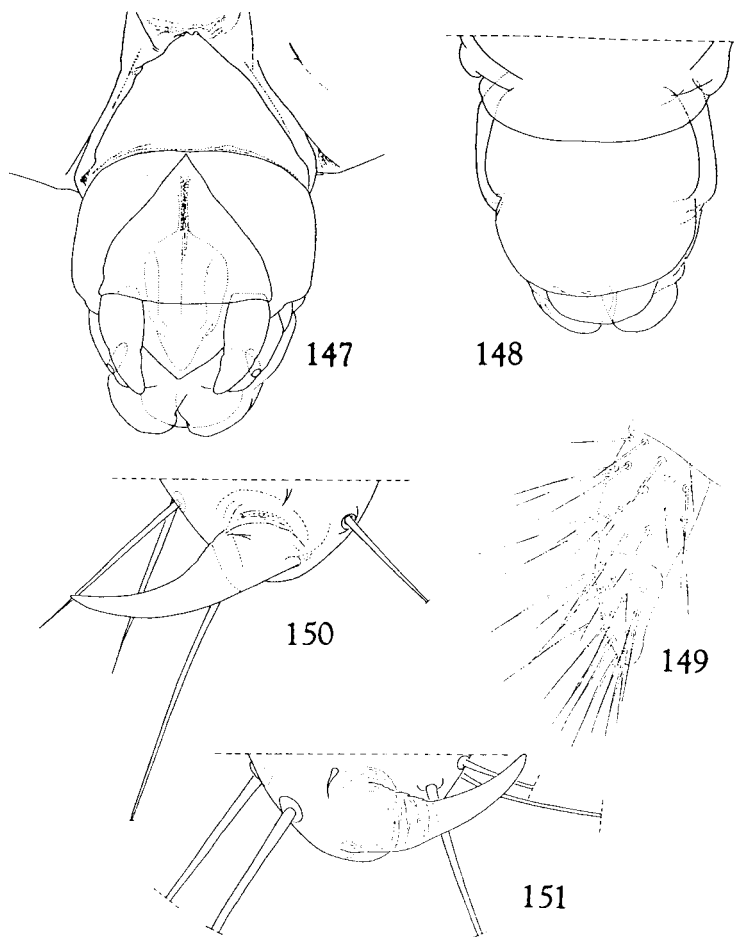

Figures 147-151. *Escaryus missouriensis* (male from Franklin Co., Missouri).
 147. Postpedal segments, ventral view. 148. The same segments, dorsal view. 149.
 Right gonopod, ventral view. 150. Apical claw of last pair of legs, right side of body.
 151. The same claw, left side of body.

←

Figures 143-146. *Escaryus missouriensis* (male from Franklin Co., Missouri).
 143. Prehensorial segment, ventral view. 144. Last pedal segment and postpedal
 segments, dorsal view. 145. Detail of sector a of preceding figure. 146. Last pedal
 segment and postpedal segments, ventral view.

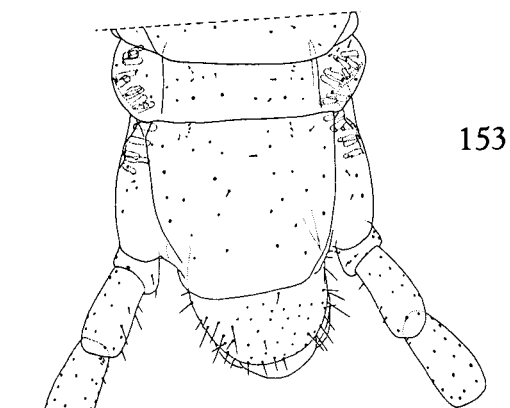

153

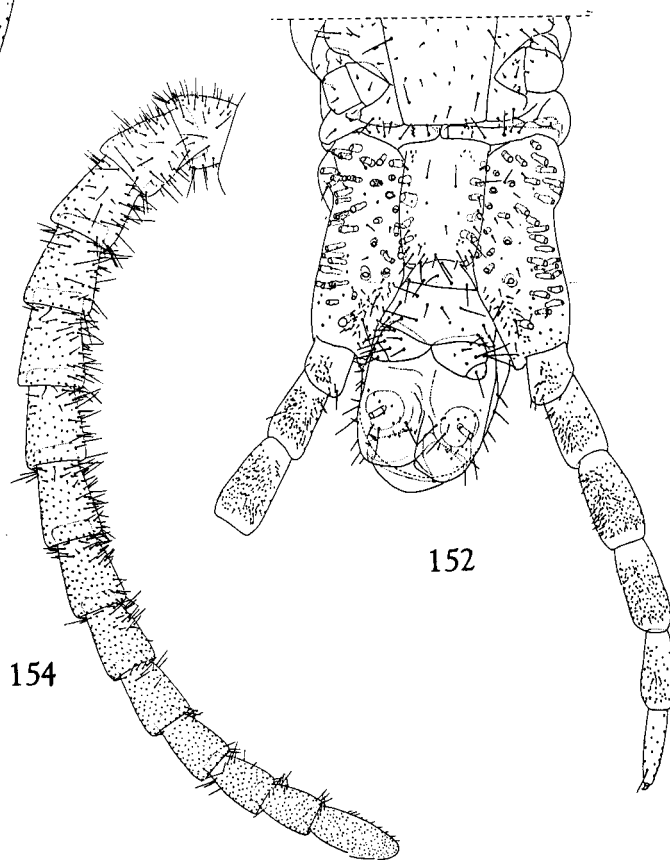

152

154

Crabill's identification of the material at hand because of general concordance of the specimens with the verbal account published by Chamberlin and their origin in the same geographic region. Chamberlin's statement that the 1st maxillae lack palps has already been pointed out by Crabill to be an error of observation.

The form of the labrum depicted in Figure 141 is a little altered by pressure of the coverslip of the preparation. The apex of the ultimate antennomere of the described specimen has the hairs missing, for this reason we are not able to include information about the apical sensory setae.

Differences in form and pilosity of the antennae between males and females indicates sexual dimorphism in this character.

Distribution: This species is known definitely known from Kansas and Missouri, and doubtfully from Indiana. Confirmed records are for MISSOURI: St. Louis and Franklin counties, and KANSAS: Baldwin County (see "Material" for detailed citations). Crabill (1953:96) reported the species from "Dallon's Spring Cave, Indiana", from a female (presumably in his personal collection) which we have not restudied. So far, despite enlisting the aid of speleobiologists familiar with Indiana caves, we have been unable to establish any trace of a Dallon's Spring Cave in that state, and must assume it to be a misspelling of the cave name or error in the state location. For this reason, we cannot include Indiana in the known range of this species although there is no *a priori* reason it should not occur there (and elsewhere in the midwestern States).

BIOGEOGRAPHY

It is a matter of interest that although the great majority of schendylids occur in tropical and subtropical regions, members of a few genera (such as *Escaryus* and *Schendyla*) are distinctly circumboreal in general distribution. Where they occur in north temperate areas, schendylids tend to be most commonly collected at substantial elevations and/or during the colder months of the year. It would be of interest to know whether psychrophily in this family is a generalized or derived character, but the present state of classification in the Geophilomorpha is so deficient that

←

Figures 152-154. *Escaryus missouriensis* (female from Douglas Co., Kansas). 152. Last pedal segment and postpedal segments, ventral view. 153. The same segments, dorsal view. 154. Right antenna, ventral view.

very little can be asserted. When even the families have not yet been adequately defined and encompassed, phylogenetic techniques cannot provide much insight. Identification of a suitable out-group for assessing polarity of various character states is hampered by uncertainty whether the group collectively called "ballophilines" is better included within the Schendylidae or excluded as components of the obvious sister-group Ballophilidae. If the inclusive option is taken, the only possible out-group for the Schendylidae must then be all other geophilomorphs collectively.

The only existing consideration of schendylid phylogeny is that of Brolemann & Ribaut (1912) who treated only a small segment of the family as now known. Their concept of the "subtribe Schendylina" excluded taxa related to *Escaryus* (referred to an undefined coordinate group "Escaryina"), but was nonetheless represented by a cladogram in which tropical forms occupied a position more basal (generalized) than the cold-adapted species grouped around *Schendyla*. Whether this inference has any substance in light of today's far greater known schendylid fauna remains to be examined. One of the striking ?apomorphies of *Escaryus* and presumably related nominal genera is the large number of coxopleural pores, a character state that seems to be restricted to the Holarctic region. This might indicate a derived condition in some way related to northward migration from a tropical ancestral region where one or two pores per coxopleuron is more general even in terms of modern geophilomorph faunas.

Species of *Escaryus* are scattered across the Holarctic Region in a pattern suggesting that of the likewise psychrophilus milliped genus *Orinisobates*. In that case, however, fragmentation of the original generic area seems to have progressed much further, as the fewer species of *Orinisobates* are far more isolated geographically from each other.

At present, and despite the handicap imposed by virtual ignorance of Eurasian schendylids, there seems to be strong evidence for transberingian migration in the case of *E. ethopus* and its very close relative (or even conspecific) *E. japonicus*. Although no species of *Escaryus* are known from western Europe, the possibility of an earlier pre-Atlantic continuum cannot be discounted either, until all members of the genus have been associated in a plausible cladogram.

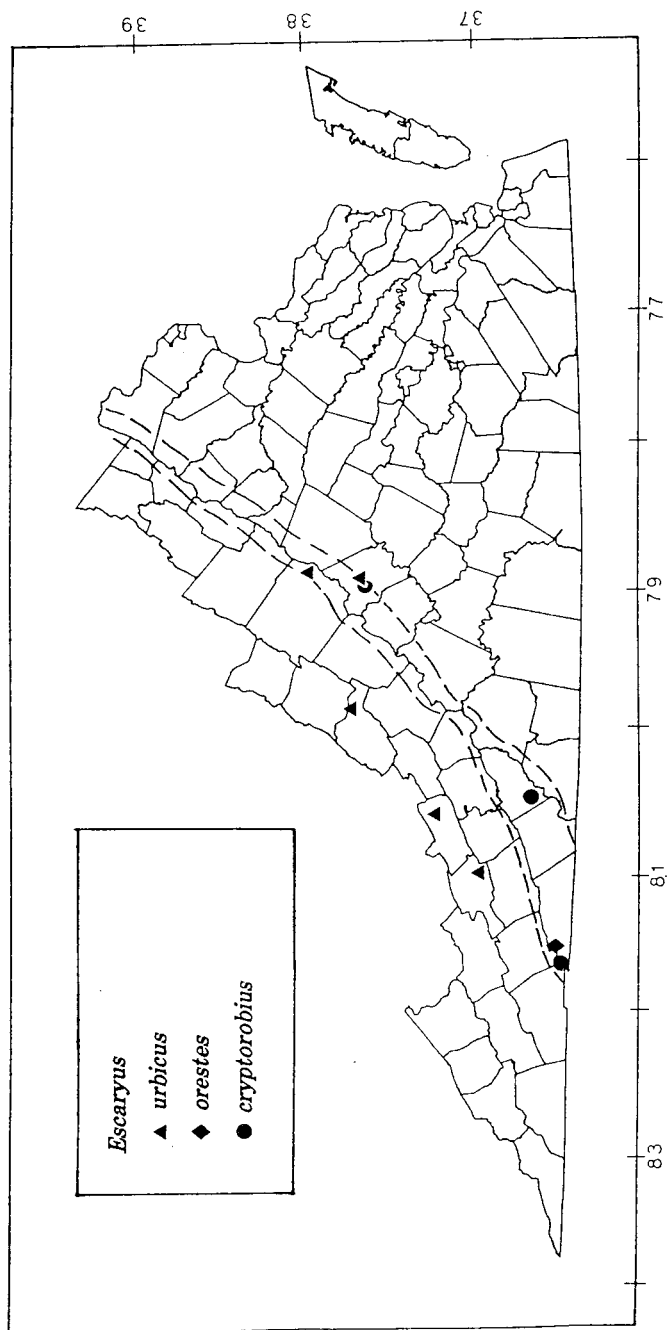

Map 3. Distribution of *Escaryus* in Virginia. The two solid lines show extent of the Blue Ridge physiographic province, to which *E. orestes* and *E. cryptorobius* appear to be confined.

REFERENCES

- Attems, C., 1903. Synopsis der Geophiliden. Zoologische Jahrbucher - Abteilung für Systematik, Geographie, und Biologie der Thiere, v. 18, p. 155-302.
- . 1904. Central-und hoch asiatische Myriopoden gesammelt im Jahre 1900 von Dr. von Almassy und Dr. von Stummer. Zoologische Jahrbucher - Abteilung für Systematik, Geographie, und Biologie der Thiere, v. 20, p. 113-130.
- . 1928. The Myriopoda of South Africa. Annals of the South African Museum, v. 26, p. 1-431.
- . 1929. Myriopoda I. Geophilomorpha, in: Das Tierreich, lief. 52, p. xxiii + 388.
- Bailey, J. W., 1928. The Chilopoda of New York State with notes on the Diplopoda. Bulletin of the New York State Museum, no. 276, p. 5-50.
- Brolemann, H.-W., and H. Ribaut, 1912. Essai d'une monographie des Schendylina (Myriapodes, Geophilomorphes). Nouvelles Archives du Museum d'Histoire naturelle (Paris), v. 5, pt. 4, pp. 53-183.
- Chamberlin, R. V., 1909. Some records of North American Geophilidae and Lithobiidae. Annals of the Entomological Society of America, v. 11, p. 175-195.
- . 1912. Notes on Geophiloidea from Iowa and some neighbouring states. Canadian Entomologist, v. 44, p. 65-72.
- . 1920. A new diplopod from Texas and a new chilopod from Alaska. Proceedings of the Biological Society of Washington, v. 33, p. 41-44.
- . 1923. Chilopoda of the Pribolof Islands, Alaska. North American Fauna, no. 46, p. 240-244.
- . 1942. Notes on a collection of centipedes chiefly from Louisiana, Arkansas and Missouri (Chilopoda). Entomological News, v. 53, p. 184-188.
- . 1946. On the chilopods of Alaska. Annals of the Entomological Society of America, v. 39, p. 177-189.
- . 1947. On four new American chilopods. The Pan-Pacific Entomologist, v. 23, p. 37-39.
- . 1947. A few chilopods taken in Panama by N. L. H. Krauss. Entomological News, v. 58, p. 146-149.
- . 1949. On some centipedes from northern Alaska. Entomological News, v. 60, p. 12-15.

- . 1952. Occurrence of a Japanese centipede in Alaska. *Entomological News*, v. 63, p. 209.
- Cook, O. F., 1895. An arrangement of the Geophilidae, a family of Chilopoda. *Proceedings of the United States National Museum*, v. 18, p. 63-75.
- . 1896. On certain Geophilidae described by Meinert. *The American Naturalist*, p. 239-243.
- . 1899. The Geophiloidea of the Florida Keys. *Proceedings of the Entomological Society of Washington*, v. 4, p. 303-312.
- . 1904. Myriapoda of Northwestern North America, in: *Harriman Alaska Expedition*, v. 8, p. 47-77.
- Cook, O. F., and G. N. Collins, 1891. Notes on North American Myriapoda of the family Geophilidae, with descriptions of three genera. *Proceedings of the United States National Museum*, v. 13, p. 383-396.
- Crabill, R. E., Jr., 1953. The Schendylidae of northeastern North America (Chilopoda: Geophilomorpha: Schendylidae). *Journal of the New York Entomological Society*, v. 61, p. 93-98.
- . 1955. A preliminary report on the Chilopoda of Missouri. *Entomological News*, v. 66, p. 36-41.
- . 1958. On a collection of centipedes from Wisconsin (Chilopoda). *Entomological News*, v. 69, p. 93-99.
- . 1961. A catalogue of the Schendylinae of North America including Mexico, with a generic key and proposal of a new *Simoporus* (Chilopoda: Geophilomorpha: Schendylinae). *Entomological News*, v. 72, p. 29-36, 67-80.
- Folkmanova, B., 1956. [On new forms of Geophilomorpha from southern provinces of USSR. Contributions to the knowledge of Myriapoda of the USSR]. *Zool. Zh.*, vol. 35, pp. 1633-1646 (in Russian).
- Kevan, D. K. McE., 1983. A preliminary survey of known and potentially Canadian and Alaskan centipedes (Chilopoda). *Canadian Journal of Zoology*, v. 61, p. 2938-2955.
- Meinert, F., 1886. Myriapoda Musei Cantabrigensis. *Proceedings of the American Philosophical Society*, v. 23, p. 161-233.
- Shinohara, K., 1970. Taxonomical and morphological studies of Myriapoda. 9. A new genus of geophilid centipede from Japan. *Zoological Magazine (Tokyo)*, v. 79, p. 53-55.
- Titova, L. P., 1972. Nouvelles espèces du genre *Escaryus* Cook et

- Collins (Schendylidae, Chilopoda). *Ecologie des Invertebres Terrestres*, Moscow, pp. 94-119 (in Russian, with French summary).
- Williams, S. R., and R. A. Hefner, 1928. The millipedes and centipedes of Ohio. *Bulletin of the Ohio State University* 33, p. 91-147.